

**CERN Program Library Long Writeups Y250**

# *HBOOK*

Reference Manual

Version 4.22

Application Software Group

Computing and Networks Division

CERN Geneva, Switzerland

Copyright Notice

**HBOOK – Statistical Analysis and Histogramming**

CERN Program Library entry **Y250**

© Copyright CERN, Geneva 1995

Copyright and any other appropriate legal protection of these computer programs and associated documentation reserved in all countries of the world.

These programs or documentation may not be reproduced by any method without prior written consent of the Director-General of CERN or his delegate.

Permission for the usage of any programs described herein is granted apriori to those scientific institutes associated with the CERN experimental program or with whom CERN has concluded a scientific collaboration agreement.

Requests for information should be addressed to:

CERN Program Library Office  
CERN-CN Division  
CH-1211 Geneva 23  
Switzerland  
Tel. +41 22 767 4951  
Fax. +41 22 767 8630  
Email: [cernlib@cern.ch](mailto:cernlib@cern.ch)

**Trademark notice: All trademarks appearing in this guide are acknowledged as such.**

*Contact Person:* Julian Bunn /CN ([julian.bunn@cern.ch](mailto:julian.bunn@cern.ch))

*Technical Realization:* Michel Goossens /CN ([michel.goossens@cern.ch](mailto:michel.goossens@cern.ch))

*Edition – January 1995*

## History

HBOOK is a Fortran<sup>1</sup> callable package for histogramming and fitting. It was originally developed in the 1970s and has since undergone continuous evolution culminating in the current version, HBOOK 4.

Many people have contributed to the design and development of HBOOK, through discussions, comments and suggestions.

For many years and up to November 1994 René Brun has been responsible for the HBOOK program. Paolo Palazzi was involved in the original design. D. Lienart has been in charge of the parametrization part. Fred James is the author of routine HDIFF and of the minimization package Minuit, which forms the basis of the fitting routines. The idea of Profile histograms has been taken from the HYDRA system. The Column-wise-Ntuple routines were implemented by Fons Rademakers. The multi-dimensional quadratic fit package HQUAD is the work of John Allison. J. Linnemann and his colleagues of the D0 experiment contributed the routine HDIFFB. Pierre Aubert is the author of the routines to associate labels with histograms. Roger Barlow and Christine Beeston (OPAL) have developed the HMCMLL package.

## Preliminary remarks

This manual serves at the same time as a **Reference manual** and as a **User Guide** for the HBOOK system. After a short introductory chapter, where the basic ideas are explained, the following chapters describe in detail the calling sequences for the different user routines.

In this manual examples are in monospace face and strings to be input by the user are underlined. In the index the page where a routine is defined is in **bold**, page numbers where a routine is referenced are in normal type.

In the description of the routines a \* following the name of a parameter indicates that this is an **output** parameter. If another \* precedes a parameter in the calling sequence, the parameter in question is both an **input** and **output** parameter.

This document has been produced using L<sup>A</sup>T<sub>E</sub>X [1] with the cernman style option, developed at CERN. A gzip compressed PostScript file `hbook.ps.gz`, containing a complete printable version of this manual, can be obtained from any CERN machine by anonymous ftp as follows (commands to be typed by the user are underlined):

```
ftp asisftp.cern.ch
Connected to asis00.cern.ch.
220 asis00 FTP server (Version wu-2.4(2)...) ready.
Name (asisftp:username): ftp
Password: your_mailaddress
230 Guest login ok, access restrictions apply.
ftp> cd cernlib/doc/ps.dir
ftp> get hbook.ps.gz (type get hbook.ps for the uncompressed version)
ftp> quit
```

---

<sup>1</sup>A C interface is also distributed by the CERN Program Library, created using the tool f2h

## Table of Contents

<b>1</b>	<b>Introduction</b>	<b>1</b>
1.1	Data processing flow in particle experiments . . . . .	1
1.2	HBOOK and its output options . . . . .	2
1.3	What you should know before you start . . . . .	3
1.3.1	HBOOK parameter conventions . . . . .	4
1.4	A basic example . . . . .	5
1.5	HBOOK batch as the first step of the analysis . . . . .	8
1.5.1	Adding some data to the RZ file . . . . .	10
1.6	HROOT interface for high quality graphics . . . . .	12
<b>2</b>	<b>One and two dimensional histograms – Basics</b>	<b>14</b>
2.1	Booking . . . . .	14
2.1.1	One-dimensional case . . . . .	14
2.1.2	Two-dimensional case . . . . .	14
2.2	Filling . . . . .	15
2.3	Editing . . . . .	16
2.4	Copy, rename, reset and delete . . . . .	17
<b>3</b>	<b>Ntuples</b>	<b>18</b>
3.1	CWN and RWN – Two kinds of Ntuples . . . . .	18
3.2	Row-Wise-Ntuples (RWN) . . . . .	20
3.2.1	Booking a RWN . . . . .	20
3.2.2	Filling a RWN . . . . .	20
3.3	More general Ntuples: Column-Wise-Ntuples (CWN) . . . . .	23
3.3.1	Booking a CWN . . . . .	24
3.3.2	Describing the columns of a CWN . . . . .	25
3.3.3	Filling a CWN . . . . .	27
3.4	Making projections of a RWN . . . . .	30
3.5	Get information about an Ntuple . . . . .	31
3.5.1	Retrieve the contents of a RWN into an array . . . . .	31
3.5.2	Retrieve the contents of a CWN into a common block . . . . .	33
3.5.3	Generate a user function . . . . .	35
3.5.4	Optimizing event loops . . . . .	37
3.6	Ntuple operations . . . . .	38
3.7	Ntuple examples . . . . .	40

<b>4</b>	<b>Advanced features for booking and editing operations</b>	<b>51</b>
4.1	Overview of booking options . . . . .	51
4.1.1	Histograms with non-equidistant bins . . . . .	51
4.1.2	Profile histograms . . . . .	51
4.1.3	Rounding . . . . .	52
4.1.4	Projections, Slices, Bands . . . . .	52
4.1.5	Statistics . . . . .	54
4.1.6	Function Representation . . . . .	55
4.1.7	Reserve array in memory . . . . .	56
4.1.8	Axis labels and histograms . . . . .	57
4.2	Filling Operations . . . . .	57
4.2.1	Fast Filling Entries . . . . .	58
4.2.2	Global Filling . . . . .	60
4.2.3	Filling histograms using character variables . . . . .	61
4.3	Editing operations . . . . .	77
4.3.1	Index and General Title . . . . .	78
4.3.2	What to Print (1-dimensional histogram) . . . . .	78
4.3.3	Graphic Choices (1-dimensional histogram) . . . . .	80
4.3.4	Scale Definition and Normalization . . . . .	81
4.3.5	Page Control . . . . .	83
4.3.6	Selective Editing . . . . .	83
4.3.7	Printing after System Error Recovery . . . . .	85
4.3.8	Changing Logical unit numbers for output and message files . . . . .	85
<b>5</b>	<b>Accessing Information</b>	<b>92</b>
5.1	Testing if a histogram exists in memory . . . . .	92
5.2	List of histograms . . . . .	92
5.3	Number of entries . . . . .	92
5.4	Histogram attributes Contents . . . . .	93
5.5	Contents . . . . .	94
5.6	Errors . . . . .	95
5.7	Associated function . . . . .	96
5.8	Abscissa to channel number . . . . .	96
5.9	Maximum and Minimum . . . . .	97
5.10	Rebinning . . . . .	97
5.11	Integrated contents . . . . .	98
5.12	Histogram definition . . . . .	98
5.13	Statistics . . . . .	99

<b>6</b>	<b>Operations on Histograms</b>	<b>100</b>
6.1	Arithmetic Operations . . . . .	100
6.2	Statistical differences between histograms . . . . .	101
6.2.1	Weights and Saturation . . . . .	102
6.2.2	Statistical Considerations . . . . .	102
6.3	Bin by bin histogram comparisons . . . . .	104
6.3.1	Choice of TOL: . . . . .	106
<b>7</b>	<b>Fitting, parameterization and smoothing</b>	<b>110</b>
7.1	Fitting . . . . .	110
7.1.1	One and two-dimensional distributions . . . . .	111
7.1.2	Fitting one-dimensional histograms with special functions . . . . .	112
7.1.3	Fitting one or multi-dimensional arrays . . . . .	113
7.1.4	Results of the fit . . . . .	114
7.1.5	The user parametric function . . . . .	115
7.2	Basic concepts of MINUIT . . . . .	116
7.2.1	Basic concepts - The transformation for parameters with limits. . . . .	116
7.2.2	How to get the right answer from MINUIT . . . . .	117
7.2.3	Interpretation of Parameter Errors: . . . . .	117
7.2.4	MINUIT interactive mode . . . . .	119
7.3	Deprecated fitting routines . . . . .	122
7.4	Parametrization . . . . .	123
7.5	Smoothing . . . . .	129
7.6	Random Number Generation . . . . .	133
7.7	Fitting with finite Monte Carlo statistics . . . . .	133
7.7.1	Example of fits . . . . .	143
<b>8</b>	<b>Memory Management and input/output Routines</b>	<b>157</b>
8.1	Memory usage and ZEBRA . . . . .	157
8.1.1	The use of ZEBRA . . . . .	157
8.2	Memory size control . . . . .	158
8.2.1	Space requirements . . . . .	158
8.3	Directories . . . . .	160
8.4	Input/Output Routines . . . . .	164
8.5	Exchange of histograms between different machines . . . . .	170
8.6	RZ directories and HBOOK files . . . . .	171

<b>9</b>	<b>Global sections and shared memory</b>	<b>173</b>
9.1	Sharing histograms in memory on remote machines . . . . .	173
9.1.1	Memory communication . . . . .	173
9.2	Mapping global sections on VMS . . . . .	173
9.2.1	Using PAW as a presenter on VMS systems (global section) . . . . .	175
9.3	Unix shared memory (Sun and DecStation only!) . . . . .	176
9.3.1	Using PAW and Unix shared memory (Sun and DecStation only) . . . . .	177
9.4	Access to remote files from a PAW session . . . . .	178
9.5	Using PAW as a presenter on OS9 systems . . . . .	179
<b>10</b>	<b>HBOOK Tabular Overview</b>	<b>180</b>

### List of Figures

1.1	Schematic presentation of the various steps in the data analysis chain . . . . .	8
1.2	Writing data to HBOOK with the creation of a HBOOK RZ file . . . . .	9
1.3	Output generated by job HTEST . . . . .	9
1.4	Adding data to a HBOOK RZ file . . . . .	11
3.1	Schematic structure of a RWN Ntuple . . . . .	19
3.2	Schematic structure of a CWN Ntuple . . . . .	19
4.1	Example of the use of HLABEL . . . . .	64
7.1	Monte Carlo distributions (left) and data distribution (right) . . . . .	143
8.1	The layout of the /PAWC/ dynamic store . . . . .	157
8.2	The ZEBRA data structure used for two-dimensional histograms . . . . .	159
8.3	Different kinds of HBOOK directories . . . . .	160
9.1	Visualise histograms in global section . . . . .	175
9.2	Visualise histograms in Unix shared memory . . . . .	177
9.3	Visualising histograms on OS9 modules from PAW . . . . .	179

### List of Tables

4.1	Available HBOOK options . . . . .	79
10.1	HBOOK Routine calling sequences . . . . .	180





## Chapter 1: Introduction

Data processing is an important aspect of particle physics experiments since the volume of data to be handled is quite large, a single LEP experiment producing of the order of a terabyte of data per year. As a result, every particle physics laboratory has a large data processing centre even though more than 50% of the computation is actually carried on in universities or other research establishments. Particle physicists from various countries are in close contact on a continental and world wide basis, the information exchanged being mainly via preprints and conferences. The similarities in experimental devices and problems, and the close collaboration, favour the adoption of common software methodologies that sometimes develop into widely used standard packages. Examples are the histograming, fitting and data presentation package HBOOK, its graphic interface `hplot` [2] and the Physics Analysis Workstation (`paw`) system [3], which have been developed at CERN.

HBOOK is a subroutine package to handle statistical distributions (histograms and Ntuples) in a Fortran scientific computation environment. It presents results graphically on the line printer, and can optionally draw them on graphic output devices via the `hplot` package. `paw` integrates the functionalities of the `hbook` and `hplot` (and other) packages into an interactive workstation environment and provides the user with a coherent and complete working environment, from reading a (mini)DST, via data analysis to preparing the final data presentation.

These packages are available from the CERN Program Library (see the copyright page for conditions). They are presently being used on several hundred different computer installations throughout the world.

### 1.1 Data processing flow in particle experiments

In the late sixties and early seventies a large fraction of particle physicists were active in bubble chamber physics. The number of events they treated varied between a few hundreds (neutrino) to several tens of thousands (e.g. strong interaction spectroscopy). Normally users would reduce their raw “measurement” tapes after event reconstruction onto Data Summary Tapes (DST) and extract from there mini and micro DSTs, which would then be used for analysis. In those days a statistical analysis program SUMX [4] would read each event and compile information into histograms, two-dimensional scatter diagrams and ‘ordered lists’. Facilities were provided (via data cards) to select subset of events according to criteria and the user could add routines for computing, event by event, quantities not immediately available.

Although the idea and formalism of specifying cuts and selection criteria in a formal way were a very nice idea, the computer technology of those days only allowed the data to be analysed in batch mode on the CDC or IBM mainframes. Therefore it was not always very practical to run several times through the data and a more lightweight system HBOOK [5, 6], easier to learn and use, was soon developed.

It was in the middle seventies, when larger proton and electron accelerators became available, that counter experiments definitively superseded bubble chambers and with them the amount of data to be treated was now in the multi megabyte range. Thousands of raw data tapes would be written, huge reconstruction programs would extract interesting data from those tapes and transfer them to DSTs. Then, to make the analysis more manageable, various physicists would write their own mini-DST, with a reduced fraction of the information from the DST. They would run these (m, $\mu$ )DSTs through HBOOK, whose functionality had increased substantially in the meantime [7, 8]. Hence various tens of one- or two-dimensional histograms would be booked in the initialization phase and the interesting parameters would be read sequentially from the DST and be binned in the histograms or scatter plots. Doing this was very efficient memory wise (although 2-dim. histograms could still be very costly), but of course all correlations, not explicitly plotted, were lost.

HBOOK in those days still had its own memory management, but with version 4 [9], which became available in 1984, the ZEBRA data memory manager was introduced. This not only allowed the use of all memory management facilities of ZEBRA, but at the same time it became possible to use the sequential FZ and random access RZ [10] input-output possibilities of that system. This allows “histograms” to be saved and transferred to other systems in an easy way. At about the same time Ntuples, somewhat similar in functionality to “events” as written on a miniDST were implemented. This way the complete correlation matrix between the various Ntuple elements can be reconstructed at will. The last few years multi Mflop machines have become available on the desktop, and “farms” of analysis machines are being set up to “interactively” reconstruct events directly from the raw data as registered in the experimental setup, hence bypassing the “batch” reconstruction step. The first Ntuple implementation can be thought of as a static large two-dimensional array, one dimension representing the number of events and the other a number of characteristics (floating point numbers) stored for each event. With the present version of HBOOK Ntuples can contain complex substructures of different data types, which allow a certain dynamism. Moreover tools have been developed to dynamically share data between various processes (Unix) or global sections (VMS). This makes it now possible to sample events as they are registered in the experimental setup or, when the computing power is available, to reconstruct, visualize and analyze events in real time as they are recorded in the experimental apparatus. It is expected that this will progressively eliminate the intermediate Batch/DST analysis step and allow, with the help of Monte Carlo events and calibration data, an (almost) immediate response to the data taking needs of a large experiment.

## 1.2 HBOOK and its output options

The HBOOK system consists of a few hundred Fortran subroutines which enable the user to symbolically define, fill and output one- and two-dimensional density estimators, under the form of **histograms**, **scatter-plots** and **tables** and to handle Ntuples.

Some interesting features of HBOOK are:

- The basic operations require the knowledge of just a few subroutine calls that can be learned in half an hour, reading a few pages of documentation. The internal structure of the package is also such that the options that are not directly called by the user program are not loaded in memory.
- Histograms and plots are represented on the line printer in a standard format that contains the picture and some numerical information. Several options are available to modify the presentation, mainly in the case of one dimensional histograms. By default, one histogram per page is printed, writing a possible common title, date, individual title, drawing the contour of the histogram between the minimum and maximum channel content, with the contents scale adjusted to fit in one page, followed by channel number, contents and scale, and some statistical information (entries, mean value, standard deviation and so on). If the number of channels is greater than 100, the histogram is printed on several pages.
- Printing options permit to add or suppress some information, choose a different graphic presentation and modify the mapping of histograms on output pages. Histograms can also be printed with channels oriented along rows instead of columns, to avoid splitting the ones with many channels. Logarithmic contents scale can be selected. Various alternative output choices are illustrated in the examples.

About 120 subroutines are directly accessible to the user program, via Fortran calls of the type

```
CALL H . . . . (P1,P2, . . .)
```

This is the only interface between a Fortran program and the dynamic data structure managed by HBOOK, which thus remains hidden from the average user.

## The functionality of HBOOK

The various user routines of HBOOK can be subdivided by functionality as follows:

<b>Booking</b>	Declare a one- or two-dimensional histogram or a Ntuple.
<b>Projections</b>	Project two-dimensional distributions onto both axes.
<b>Ntuples</b>	Way of writing micro data-summary-files for further processing. This allows projections of individual variables or correlation plots. Selection mechanisms may be defined.
<b>Function representation</b>	Associates a real function of 1 or 2 variables to a histogram.
<b>Filling</b>	Enter a data value into a given histogram, table or Ntuple.
<b>Access to information</b>	Transfer of numerical values from HBOOK-managed memory to Fortran variables and back.
<b>Arithmetic operations</b>	On histograms and Ntuples.
<b>Fitting</b>	Least squares and maximum likelihood fits of parametric functions to histogrammed data.
<b>Monte Carlo testing</b>	Fitting with finite Monte Carlo statistics.
<b>Differences between histograms</b>	Statistical tests on the compatibility in shape between histograms using the Kolmogorov test.
<b>Parameterization</b>	Expresses relationships between as linear combinations of elementary functions.
<b>Smoothing</b>	Splines or other algorithms.
<b>Random number generation</b>	Based on experimental distributions.
<b>Archiving</b>	Information is stored on mass storage for further reference in subsequent programs.
<b>Editing</b>	Choice of the form of presentation of the histogrammed data.

### 1.3 What you should know before you start

The basic data elements of HBOOK are the **histogram** (one- and two-dimensional) and the **Ntuple**. The user identifies his data elements using a **single integer**. Each of the elements has a number of **attributes** associated with it.

The package is organised as part of a **library**, from which at load time unsatisfied externals are searched and loaded. In this way only those subroutines actually used will be loaded, therefore minimising the space occupied in memory by the code. Unfortunately, given the way Fortran works and although the package is structured as much as possible in the sense of selective loading, some unused subroutines will usually be present.

HBOOK uses the ZEBRA [10] data structure management package to manage its memory (see chapter 8). The working space of HBOOK is an array, allocated to the labelled common /PAWC/. In ZEBRA terms this is a ZEBRA store. It is thus necessary to reserve as many locations as required with a declarative statement in the main program. The actual length of the common is defined most safely via a PARAMETER statement, as shown below:

```
PARAMETER (NWPASC = 50000)
COMMON /PAWC/ HMEMOR(NWPASC)
```

Furthermore HBOOK must be informed of the storage limit via a call to HLIMIT. This is discussed in detail in section 8.2 on page 158. In the case above this would correspond to

```
CALL HLIMIT(NWPASC)
```

At execution time, when histograms are booked, they are accommodated in common /PAWC/ in booking order, up to the maximum size available.

Note that a call to HLIMIT will automatically initialise the ZEBRA system via a call to the routine MZEBRA. If ZEBRA has already been initialised, (MZEBRA has already been called), then HLIMIT should be called with a **negative** number indicating the number of words required, e.g.

```
CALL HLIMIT(-NWPASC)
```

### 1.3.1 HBOOK parameter conventions

#### Histogram or Ntuple Identifiers

Histograms and Ntuples in HBOOK are identified by a positive or negative integer. Thus the histogram identifier  $ID = 0$  is illegal at **booking** time. However it is a convenient way to specify that the option or operation applies to **all** known histograms in the current working directory (e.g. output, input, printing). All routines for which a zero identifier is meaningful are mentioned explicitly.

#### Parameter types

In agreement with the Fortran standard, when calling an HBOOK routine the type of each parameter must correspond to the one described in the routine's calling sequence in this manual. Unless explicitly stated otherwise, parameters whose names start with I, J, K, L, M or N are **integer**, the rest **real**, with the exception of those beginning with the string CH, which correspond to character constants.

#### Data packing

All booking commands that reserve space for histograms or plots require the "packing" parameter VMX. It corresponds to the estimated maximum population of a single bin, on the basis of which a suitable number of bits per channel will be allocated. This allows several channels to be packed in one machine word, and thus to require less storage space (at the expense of packing and unpacking processing time). A value  $VMX=0.0$  signals that no packing is to be performed and that each histogram channel will occupy one machine word.

## 1.4 A basic example

Below a simple example is given describing how to use HBOOK for booking, filling and printing simple histograms. After telling HBOOK the length of the /PAWC/ common block to be 10000 words with a call to HLIMIT, a global title to appear on all histograms is specified by calling HTITLE. Next a 100 bin one-dimensional histogram with identifier 10 is booked with a call to HBOOK1, followed by the booking using a call to HBOOK2 of a two-dimensional histogram with identifier 20 and consisting of 100 times 40 cells. The D0-loop labelled 10 fills the one-dimensional histogram 10, while the nested D0 loops labelled 20 and 30 look after filling the two-dimensional histogram 20. In both cases a call is made to routine HFILL. Finally a call to HISTD0 writes an index with information about all histograms as well as a lineprinter representation of the histograms on standard output.

### Example of how to produce simple histograms

```

PROGRAM HSIMPLE
*
  PARAMETER (NWPAWC = 10000)
  COMMON/PAWC/H(NWPAWC)
* -----
  CALL HLIMIT(NWPAWC)
*           Set global title
*
  CALL HTITLE('EXAMPLE NO = 1')
*           Book 1-dim histogram and scatter-plot
*
  CALL HBOOK1(10,'EXAMPLE OF 1-DIM HISTOGRAM',100,1.,101.,0.)
  CALL HBOOK2(20,'EXAMPLE OF SCATTER-PLOT',100,0.,1.,40,1.,41.,30.)
*           Fill 1-dim histogram
*
  DO 10 I=1,100
    W=10*MOD(I,25)
    CALL HFILL(10,FLOAT(I)+0.5,0.,W)
10 CONTINUE
*           Fill scatter-plot
*
  X=-0.005
  DO 30 I=1,100
    X=X+0.01
    DO 20 J=1,40
      Y=J
      IW=MOD(I,25)*MOD(J,10)
      IWMAX=J-MOD(I,25)+10
      IF(IW.GT.IWMAX)IW=0
      CALL HFILL(20,X,Y,FLOAT(IW))
20 CONTINUE
30 CONTINUE
*           Print all histograms with an index
*
  CALL HISTD0
  END

```

### Output Generated

EXAMPLE NO = 1

HBOOK	HBOOK	CERN	VERSION	4.13	HISTOGRAM AND PLOT INDEX						17/12/91	
NO	TITLE			ID	B/C	ENTRIES	DIH	NCHA	LOWER	UPPER	ADDRESS	LENGTH
1	EXAMPLE OF 1-DIH HISTOGRAM			10	32	100	1 X	100	0.100E+01	0.101E+03	79369	149
2	EXAMPLE OF SCATTER-PLOT			20	5	4000	2 X Y	100 40	0.000E+00 0.100E+01	0.100E+01 0.410E+02	79217 78482	760 726

MEMORY UTILISATION

MAXIMUM TOTAL SIZE OF COMMON /PASC/ 80000

EXAMPLE NO = 1

EXAMPLE OF 1-DIH HISTOGRAM

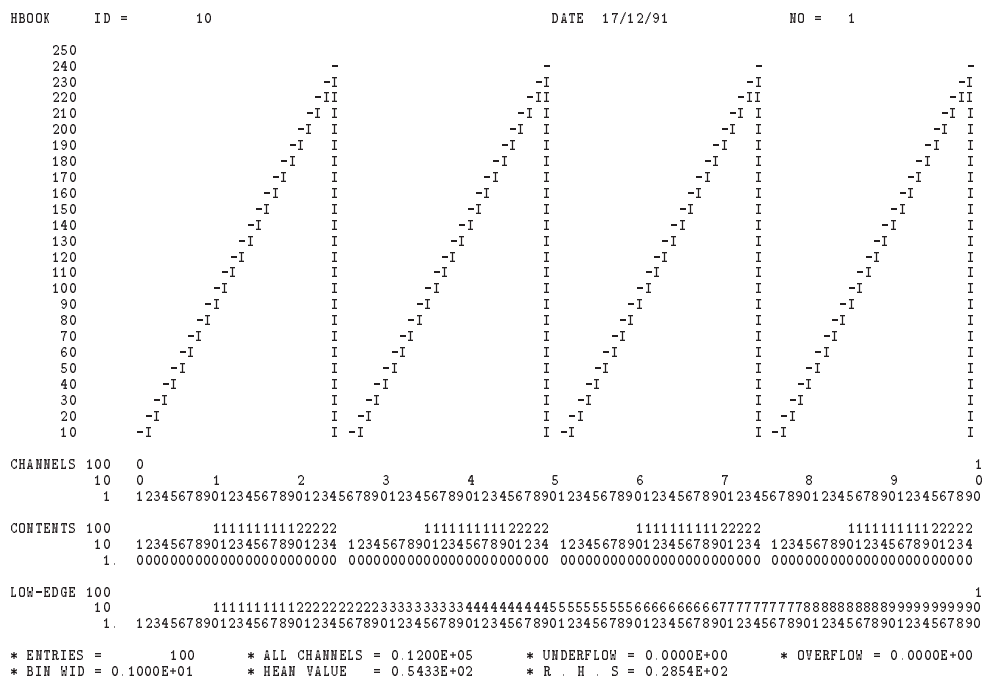

1.4. A basic example

EXAMPLE NO = 1

EXAMPLE OF SCATTER-PLOT

HBOOK ID = 20 DATE 17/12/91 NO = 2

CHANNELS 100 U 0 10 H 0 1 2 3 4 5 6 7 8 9 10 V 0 V
1 D 1234567890123456789012345678901234567890123456789012345678901234567890 E

OVE \* OVE
40 \* 40
39 \* 9IR\* 9IR\* 9IR\* 9IR\* \* 39
38 \* 8G0\*\* 8G0\*\* 8G0\*\* 8G0\*\* \* 38
37 \* 7ELS\* 7ELS\* 7ELS\* 7ELS\* \* 37
36 \* 6CIOU\* 6CIOU\* 6CIOU\* 6CIOU\* \* 36
35 \* 5AFKPU\* 5AFKPU\* 5AFKPU\* 5AFKPU\* \* 35
34 \* 48CGKOS\* 48CGKOS\* 48CGKOS\* 48CGKOS\* \* 34
33 \* 369CFILORU 369CFILORU 369CFILORU 369CFILORU \* 33
32 \* 2468ACEGIKHOQS 2468ACEGIKHOQS 2468ACEGIKHOQS 2468ACEGIKHOQS \* 32
31 \* +23456789ABCDEFGHIJK +23456789ABCDEFGHIJK +23456789ABCDEFGHIJK +23456789ABCDEFGHIJK \* 31
30 \* 30
29 \* 9IR 9IR 9IR 9IR \* 29
28 \* 8G0\* 8G0\* 8G0\* 8G0\* \* 28
27 \* 7ELS 7ELS 7ELS 7ELS \* 27
26 \* 6CIOU 6CIOU 6CIOU 6CIOU \* 26
25 \* 5AFKP 5AFKP 5AFKP 5AFKP \* 25
24 \* 48CGKO 48CGKO 48CGKO 48CGKO \* 24
23 \* 369CFILO 369CFILO 369CFILO 369CFILO \* 23
22 \* 2468ACEGIK 2468ACEGIK 2468ACEGIK 2468ACEGIK \* 22
21 \* +23456789ABCDEF +23456789ABCDEF +23456789ABCDEF +23456789ABCDEF \* 21
20 \* 20
19 \* 9I 9I 9I 9I \* 19
18 \* 8G0 8G0 8G0 8G0 \* 18
17 \* 7EL 7EL 7EL 7EL \* 17
16 \* 6CI 6CI 6CI 6CI \* 16
15 \* 5AFK 5AFK 5AFK 5AFK \* 15
14 \* 48CG 48CG 48CG 48CG \* 14
13 \* 369CF 369CF 369CF 369CF \* 13
12 \* 2468ACE 2468ACE 2468ACE 2468ACE \* 12
11 \* +23456789A +23456789A +23456789A +23456789A \* 11
10 \* 10
9 \* 9 9 9 9 \* 9
8 \* 8G 8G 8G 8G \* 8
7 \* 7E 7E 7E 7E \* 7
6 \* 6C 6C 6C 6C \* 6
5 \* 5A 5A 5A 5A \* 5
4 \* 48 48 48 48 \* 4
3 \* 369 369 369 369 \* 3
2 \* 2468 2468 2468 2468 \* 2
1 \* +2345 +2345 +2345 +2345 \* 1
UND \* UND

LOW-EDGE 0 000000000111111111222222223333333344444444555555556666666677777777888888889999999999
0 012345678901234567890123456789012345678901234567890123456789012345678901234567890123456789

\* ENTRIES = 4000 PLOT -----I-----I-----
\* SATURATION AT= 31 I 10488I
\* SCALE .+,2,3,, , A,B, STATISTICS -----I-----I-----
\* STEP = 1.00 \* MINIHUH=0.000 I I

## 1.5 HBOOK batch as the first step of the analysis

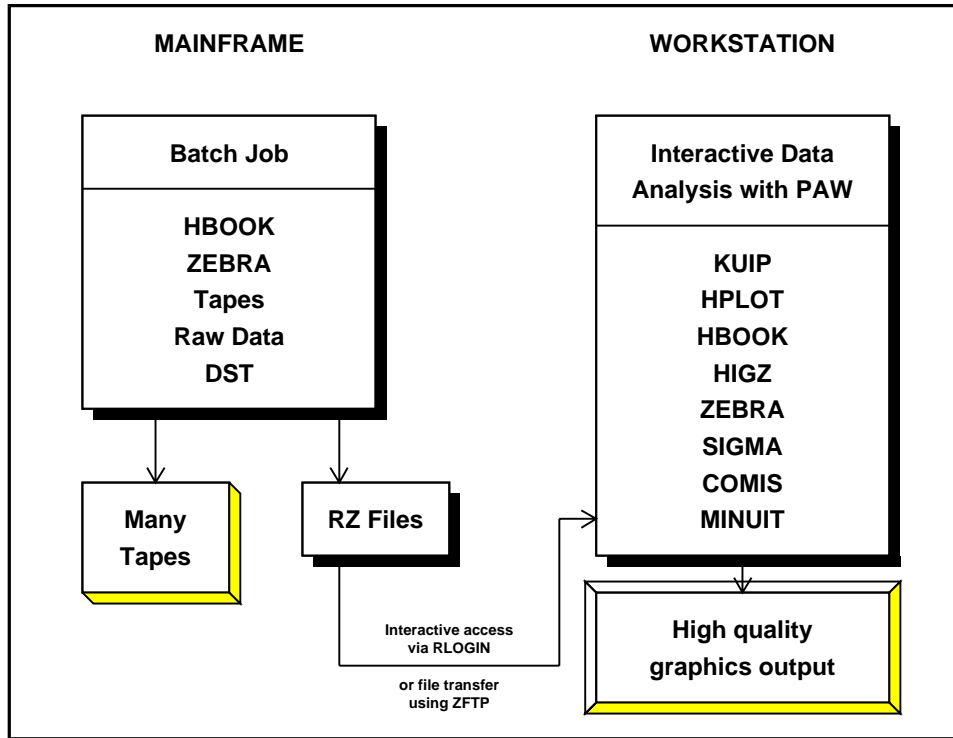

Figure 1.1: Schematic presentation of the various steps in the data analysis chain

Although it is possible to define histograms interactively in a PAW session, and then read the (many thousands of) events, in general for large data samples the relevant variables are extracted from the **Data Summary Files** or **DSTs** and stored in **histograms** or an **Ntuple**. Histograms require to make a certain choice as to the range of values for the plotted parameter, because the **binning**, or the coarseness, of the distribution has to be specified when the histogram is defined (**booked**). Also only one- and two-dimensional histograms are possible, hence the correlations between various parameters can be difficult to study. Hence in many cases it is more appropriate to store the value of the important parameters for each event in an **Ntuple**. This approach preserves the correlation between the parameters and allows selection criteria to be applied on the (reduced) data sample at a later stage.

In general, the time consuming job of analysing all events available on tape is run on a mainframe or CPU server, and the important event parameters are stored in a Ntuple to allow further detailed study. For convenience the Ntuple can be output to disk for each run, and then at a later stage the Ntuples can be **merged** in order to allow a global interactive analysis of the complete data sample (see Figure 1.1).

A typical batch job in which data are analysed offline and some characteristics are stored in HBOOK is shown in Figure 1.2. HBOOK is initialised by a call to HLIMIT, which declares a length of 20000 words for the length of the /PAWC/ dynamic store. Then the one- and two- dimensional histograms 110 and 210 are filled respectively according to the functions HTFUN1 and HTFUN2 and the histograms are output to a newly created file HTEST.DAT. The output generated by the program is shown in Figure 1.3.



```

PROGRAM HTEST
PARAMETER (NHPAWC=20000)
COMMON/PAWC/H(NHPAWC)
EXTERNAL HTFUN1,HTFUN2
* -----
CALL HLIMIT(NHPAWC)
*      Book histograms and declare functions
CALL HBFUN1(100,'Test of HRNDM1',100,0.,1.,HTFUN1)
CALL HBOOK1(110,'Filled according to HTFUN1',100,0.,1.,1000.)
CALL HBFUN2(200,'Test of HRNDM2',100,0.,1.,40,0.,1.,HTFUN2)
CALL HSCALE(200,0.)
CALL HBOOK2(210,'Filled according to HTFUN2',100,0.,1.,40,0.,1.,30.)
*      Fill histograms
DO 10 I=1,10000
  X=HRNDM1(100)
  CALL HFILL(110,X,0.,1.)
  CALL HRNDM2(200,X,Y)
  CALL HFILL(210,X,Y,1.)
10 CONTINUE
*      Save all histograms on file HTEST.DAT
CALL HRPUT(0,'HTEST.DAT','N')
CALL HDELET(100)
CALL HDELET(200)
CALL HPRINT(0)
END
FUNCTION HTFUN2(X,Y)
  Two-dimensional gaussian
HTFUN2=HTFUN1(X)*HTFUN1(Y)
RETURN
END
FUNCTION HTFUN1(X)
  Constants for gaussians
DATA C1,C2/1.,0.5/
DATA XM1,XM2/0.3,0.7/
DATA XS1,XS2/0.07,0.12/
*      Calculate the gaussians
A1=-0.5*((X-XM1)/XS1)**2
A2=-0.5*((X-XM2)/XS2)**2
X1=C1
X2=C2
IF (ABS(A1).GT.0.0001)X1=C1*EXP(A1)
IF (ABS(A2).GT.0.0001)X2=C2*EXP(A2)
*      Return function value
HTFUN1=X1*X2
RETURN
END
  
```

Figure 1.2: Writing data to HBOOK with the creation of a HBOOK RZ file

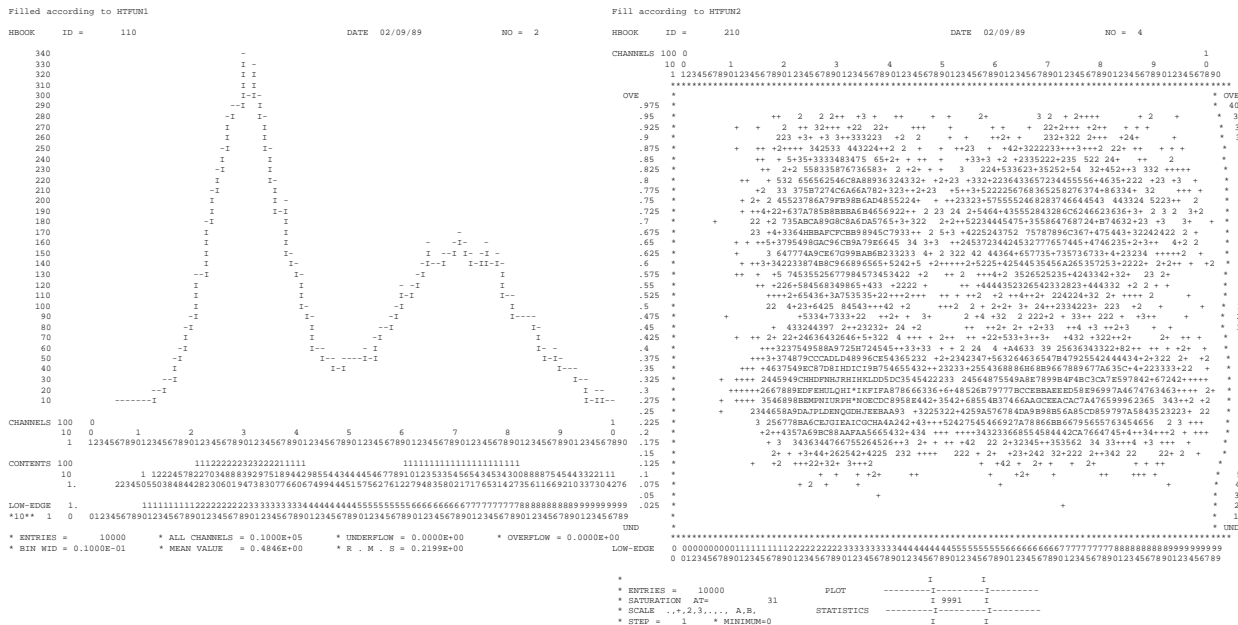

Figure 1.3: Output generated by job HTEST

### 1.5.1 Adding some data to the RZ file

A second run using program HTEST1 below shows how to add some data to the HBOOK RZ file created in the job HTEST (Figure 1.2). After opening the file HTEST.DAT, created in the previous run, in update mode ('U' option) with the name EXAM2, a new directory NTUPLE is created, known as //EXAM2/NTUPLE as seen in the output of HLDIR command at the end of the output. One-dimensional (10) and two-dimensional (20) histograms and an Ntuple (30) are booked. Each Ntuple element or "event" is characterised by three **variables** (labelled 'X', 'Y' and 'Z'). The Ntuple data, when the initial size of 1000 words is exhausted, will be written to the directory on disk specified in the call to HBOOKN, i.e. //EXAM2/NTUPLE, and the data in memory are replaced with those newly read. A one- and a two-dimensional projection of X and X/Y are then made onto histograms 10 and 20 respectively, before they are printed and written on the HBOOK RZ file. At the end the **current** and **parent** directories are listed. The contents of the latter shows that the data written in the first job (HTEST) are indeed still present in the file under the top directory //EXAM2. The call to RZSTAT shows usage statistics about the RZ file.

#### Example of adding data to a HBOOK RZ file

```

PROGRAM HTEST1
PARAMETER (NWPAWC=20000)
COMMON/PAWC/H(NWPAWC)
DIMENSION X(3)
CHARACTER*8 CHTAGS(3)
DATA CHTAGS/' X ', ' Y ', ' Z '/
*-----
CALL HLIMIT(NWPAWC)
*       Reopen data base
LRECL = 0
CALL HROPEN(1, 'EXAM2', 'HTEST.DAT', 'U', LRECL, ISTAT)
CALL HMDIR('NTUPLE', 'S')
CALL HBOOK1(10, 'TEST1', 100, -3., 3., 0.)
CALL HBOOK2(20, 'TEST2', 30, -3., 3., 30, -3., 3., 250.)
CALL HBOOKN(30, 'N-TUPLE', 3, '//EXAM2/NTUPLE',
+         1000, CHTAGS)
*
DO 10 I=1, 10000
  CALL RANNOR(A, B)
  X(1)=A
  X(2)=B
  X(3)=A*A+B*B
  CALL HFN(30, X)
10 CONTINUE
*
CALL HPROJ1(10, 30, 0, 0, 1, 999999, 1)
CALL HPROJ2(20, 30, 0, 0, 1, 999999, 1, 2)
CALL HPRINT(0)
CALL HROUT(0, ICYCLE, ' ')
CALL HLDIR(' ', ' ')
CALL HCDIR('\', ' ')
CALL HLDIR(' ', ' ')
CALL RZSTAT(' ', 999, ' ')
CALL HREND('EXAM2')
END

```



## 1.6 HPLOT interface for high quality graphics

hplot is a package of Fortran subroutines for producing hbook output suitable for graphic devices or in PostScript. It is designed to produce drawings and slides of a quality suitable for presentations at conferences and scientific publications. It does not produce all the numerical information of the HBOOK output routines. It is not restricted by the line printer's poor resolution and unique character sets but it uses the full graphics capabilities of the targeted output device.

HPLOT can access an HBOOK data structure and transform it into drawings using the HIGZ graphics package. Some of the available options are :

- Predefined ISO standard paper size (A4, A3, etc.), horizontal or vertical orientation, with suitable margins. Other sizes are also possible.
- Combination of several plots on the same page, either by windowing or superimposition, or both, with different symbols to distinguish them.
- Titles on the axes and text anywhere on the picture, using various fonts, containing, e.g., Greek or special characters.
- Three-dimensional surface representations for two-dimensional histograms (with hidden-line and hidden-surface removal).
- Colour (if the hardware allows it), hatching, grey levels,....

As a simple example of the use of HPLOT let us consider a program similar to the one in Figure 1.4. After opening a file on unit 10 to write the metafile output (Fortran OPEN statement), we book, then fill the Ntuple projections, and finally plot them. The call to HPLINT initialises HPLOT and HPLCAP redirects the metafile output to unit 10. The parameters given to HPLOT instruct the program to output all histograms in the current working directory to the metafile using “standard” option, while HPLEND closes the metafile. See the HPLOT user's guide [2] for more details. The result of the job and the resulting PostScript file can be compared to the “lineprinter” output in Figure 1.4.

### Example of a simple HPLOT program

```

PROGRAM HPTEST
COMMON/PAWC/H(80000)
DIMENSION X(3)
CHARACTER*8 CHTAGS(3)
DATA CHTAGS/' X ',' Y ',' Z '/
*-----
CALL HLIMIT(80000)
*
  Reopen data base
OPEN(UNIT=10,file='hplot.meta',form='formatted',status='unknown')
CALL HBOOK1(10,'TEST1',100,-3.,3.,0.)
CALL HBOOK2(20,'TEST2',30,-3.,3.,30,-3.,3.,250.)
CALL HBOOKN(30,'N-TUPLE',3,' ',1000,CHTAGS)
*
DO 10 I=1,10000
  CALL RANNOR(A,B)
  X(1)=A
  X(2)=B
  X(3)=A*A+B*B
  CALL HFN(30,X)
10 CONTINUE
*
```

```
CALL HPROJ1(10,30,0,0,1,999999,1)
CALL HPROJ2(20,30,0,0,1,999999,1,2)
CALL HPLINT(0)
CALL HPLCAP(-10)
CALL HPLOTT(0,' ',' ',0)
CALL HPLEND
CALL HINDEX
END
```

**Output Generated**

Version 1.13/05 of HIGZ started

HBOOK	HBOOK	CERN	VERSION	4.13	HISTOGRAM AND PLOT INDEX					06/02/92	
NO	TITLE	ID	B/C	ENTRIES	DIH	NCHA	LOWER	UPPER	ADDRESS	LENGTH	
1	TEST1	10	32	10000	1	X	100	-0.300E+01	0.300E+01	78388	144
2	TEST2	20	8	10000	2	X Y	30 30	-0.300E+01 -0.300E+01	0.300E+01 0.300E+01	78240 77963	298 268
3	N-TUPLE	30				N				77914	39

MEMORY UTILISATION  
 MAXIMUM TOTAL SIZE OF COMMON /PAWC/ 80000

Output generated by HPLLOT on printer with graphics capabilities

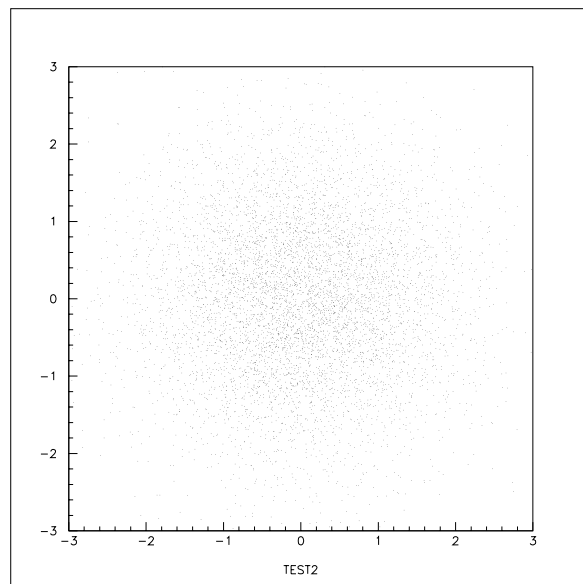
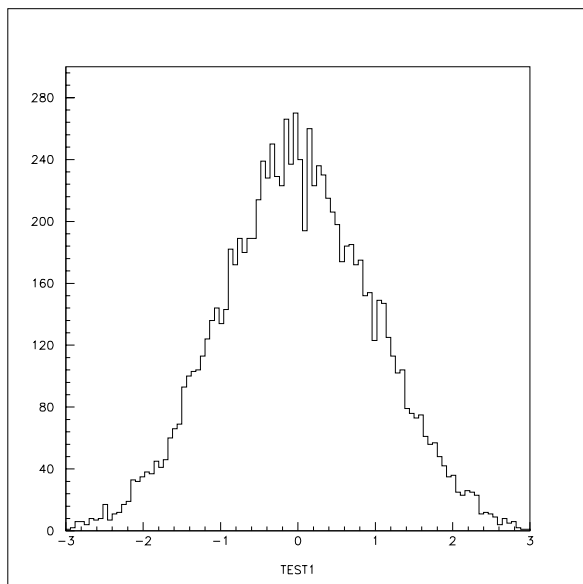

## Chapter 2: One and two dimensional histograms – Basics

### 2.1 Booking

#### 2.1.1 One-dimensional case

```
CALL HBOOK1 (ID,CHTITL,NX,XMI,XMA,VMX)
```

**Action:** Books a one-dimensional histogram.

**Input parameter description:**

ID	histogram identifier, integer non zero
CHTITL	histogram title (character variable or constant up to 80 characters)
NX	number of channels
XMI	lower edge of first channel
XMA	upper edge of last channel
VMX	upper limit of single channel content (see below). VMX=0. means 1 word per channel (no packing).

**Special values:**

- If  $XMA \leq XMI$ , origin and binwidth are calculated automatically, and one word is reserved per channel.
- Zero (0) is an illegal histogram identifier.
- If the histogram ID already exists it will be deleted and recreated with the new specifications. A warning message is printed.
- VMX is used to compute the number of bits to be allocated per histogram channel. If  $VMX < 1$ . then one full word is reserved per channel. When filling a histogram with weights the latter are truncated to the nearest integer unless one full word is reserved per channel (i.e.  $VMX = 0.$ ). Filling with negative weights will give meaningless results unless one word per channel has been allocated. Automatic calculation of limits ( $XMA \leq XMI$ ) forces one word per channel.

#### 2.1.2 Two-dimensional case

```
CALL HBOOK2 (ID,CHTITL,NX,XMI,XMA,NY,YMI,YMA,VMX)
```

**Action:** Books a two-dimensional histogram.

**Input parameter description:**

ID	histogram identifier, integer
CHTITL	histogram title (character variable or constant up to 80 characters)
NX	number of channels in X

XMI	lower edge of first X channel
XMA	upper edge of last X channel
NY	number of channels in Y
YMI	lower edge of first Y channel
YMA	upper edge of last Y channel
VMX	maximum population to store in 1 cell.

**Remarks:**

- Similar to HBOOK1, apart from automatic binning.
- By default, a 2-dimensional histogram will be printed as a scatterplot.
- If the option TABL is selected via CALL HIDOPT (ID, 'TABL') the 2-dimensional histogram will be printed as a table.
- When editing the table, the number of columns NCOL used to write the content of one cell depends on the value of VMX as follows  $NCOL = \text{ALOG}_{10}(VMX) + 2$ . When VMX is zero, the contents is printed in 10 columns in floating point format (including sign). If necessary, all contents are multiplied by a power of 10, this number being reported at the bottom of the table.

**2.2 Filling**

```
CALL HFILL (ID,X,Y,WEIGHT)
```

**Action:** Fills a 1-dimensional or a 2-dimensional histogram. The channel which contains the value X and for two-dimensionals the cell that contains the point (X,Y), gets its contents increased by WEIGHT. All booked projections, slices, bands, are filled as well.

**Input parameter description:**

ID	histogram identifier
X	value of the abscissa
Y	value of the ordinate
WEIGHT	event weight (positive or negative)

**Remarks:**

- If one full word per channel is reserved at booking time, WEIGHT is taken with its floating point value. In case of packing (i.e. more than one channel per word), WEIGHT must be positive and will be truncated to the nearest integer (WEIGHT<0 will give meaningless results)
- See section 4.2 on page 57 for alternative filling routines.

## 2.3 Editing

```
CALL HISTDO
```

**Action:** Outputs all booked histograms to the line printer. An index is printed at the beginning specifying the characteristics and storage use of each histogram.

**Remark:**

- If a histogram is empty, a message declares this condition, and the histogram is not printed.

```
CALL HPRINT (ID)
```

**Action:** Outputs a given histogram to the line printer.

ID           Histogram identifier.

**Remarks:**

- CALL HPRINT(0) is equivalent to CALL HISTDO apart from not printing the index
- When a histogram is empty a message declares this condition and the histogram is not printed.

Some available booking options are shortly listed below. For a full description see chapter 4.

- Creation of histograms with non-equidistant bins
- Creation of profile histograms
- Rounded scale
- Projections and slices of 2-dimensional histograms
- More statistical information
- Comprehensive booking and filling with user-supplied functions of one or two real variables.
- Dynamic creation of ordinary Fortran arrays (HARRAY)



## 2.4 Copy, rename, reset and delete

```
CALL HCOPY (ID1, ID2, CHTITL)
```

**Action:** Generates histogram ID2 as a copy of ID1, apart from the title.

**Input parameter description:**

ID1        existing identifier  
ID2        non existing identifier  
CHTITL    new title. CHTITL=' ' means that the old title is kept.

```
CALL HRENID (IDOLD, IDNEW)
```

**Action:** Renames a histogram or Ntuple.

**Input parameter description:**

IDOLD    Old histogram identifier.  
IDNEW    New histogram identifier.

```
CALL HRESET (ID, CHTITL)
```

**Action:** Resets the contents of all channels of a histogram (and its projections) or Ntuple to zero and changes optionally the title.

**Input parameter description:**

ID        identifier of a histogram. ID=0 resets all existing histogram contents.  
CHTITL    new title. CHTITL=' ' means that the old title is kept.

```
CALL HDELETE (ID)
```

**Action:** Deletes a histogram and releases the corresponding storage space.

**Input parameter description:**

ID        identifier of a histogram. ID=0 deletes all existing histograms.

See section 1.4 in the introductory chapter for a simple example of how to book, fill and print histograms.

## Chapter 3: Ntuples

To introduce the concept of Ntuples, let us consider the following example. A Data Summary Tape (DST) contains 10000 events. Each event consists of many variables (say  $NVAR=200$ ) for which we would like to make some distributions according to various selection criteria.

One possibility is to create and fill 200 histograms on an event-by-event basis while reading the DST. An alternative solution, particularly interesting during interactive data analysis with the data presentation system `paw` [3], is to create one Ntuple. Instead of histogramming the 200 variables directly, and therefore losing the exact values of the variables for each event and their correlations, the variables are first stored in an Ntuple. (One can of course fill the histograms at the same time!) An Ntuple is like a table where the 200 variables mentioned above are the columns and each event is a row. The storage requirement is proportional to the number of columns in one event and can become significant for large event samples. An Ntuple can thus be regarded as a standard way of storing a DST.

Once the events are stored in this form, it becomes easy, in particular with `paw`, to make 1- or more-dimensional projections of any of the  $NVAR$  variables of the events and to change the selection mechanisms, or the binning and so on. Before running the system on a large number of events, the selection mechanisms can be rapidly tested on a small sample.

### 3.1 CWN and RWN – Two kinds of Ntuples

In a *Row-Wise-Ntuple (RWN)* the elements of each row, usually corresponding to an individual event, are stored contiguously in an HBOOK RZ file. This storage method is similar to that of a conventional DST, where events are stored sequentially and it is particularly suited for small Ntuples (up to a few Mbytes), with only a few columns. You can even use an RWN for larger Ntuples (up to about 20 Mbytes) when you know you want to reference almost all columns in your query commands. A RWN should not be used if there are more than about 100 columns, or when your queries only references a small number of columns. A RWN can only contain floating point data. It is created with `HBOOKN` and filled with `HFN`. Routines `HGN`, `HGNF` are used to retrieve information about one row.

Figure 3.1 shows schematically how a RWN is laid out in memory, row after row. The buffer size in memory `NWBUFF` is specified as the primary allocation parameter `NWBUFF` of the `HBOOKN` routine. Of course, you must have reserved sufficient space in the `/PAWC/` common when calling the HBOOK initialization routine `HLIMIT`. The lower line shows how the information is written to an RZ file. The length of the input/output buffer `LRECL` is specified as an argument of the routine `HROPEN`. It is evident that, if you have a small Ntuple and a lot of memory, you can fit the complete Ntuple in memory, thus speeding up the Ntuple operations.

In a *Column-Wise-Ntuple (CWN)* the elements of each column are stored sequentially. Data in such an Ntuple can be accessed in a much more flexible and powerful manner than for a RWN. The CWN storage mechanism has been designed to substantially improve access time and facilitate compression of the data, thereby permitting much larger event samples (several hundreds of Mbytes) to be interactively processed, e.g. using `paw`. Substantial gains in processing time can be obtained, especially if your queries only reference a few columns. A CWN is not limited to floating point data, but can contain all basic data types (real, integer, unsigned integer, logical or character). A CWN is created with routines `HBNT`, `HBNAMC` and filled with `HFNT` and `HFNTB`. Information about one row/block/column can be retrieved with routines `HGNT`, `HGNTB`, `HGNTV` and `HGNTF`.

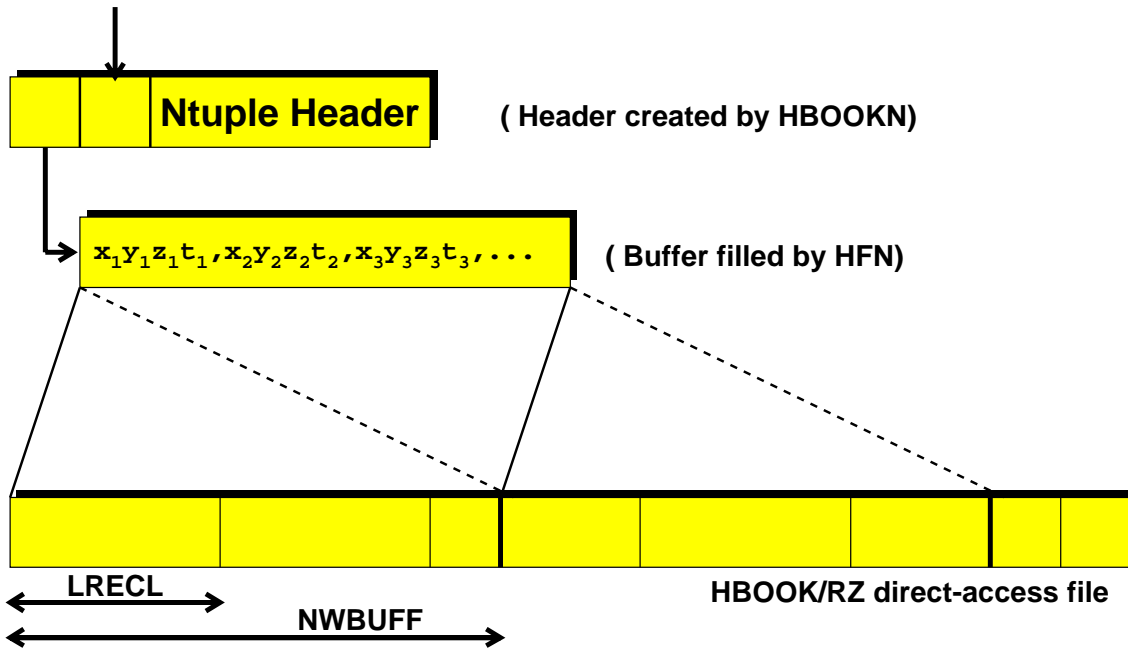

Figure 3.1: Schematic structure of a RWN Ntuple

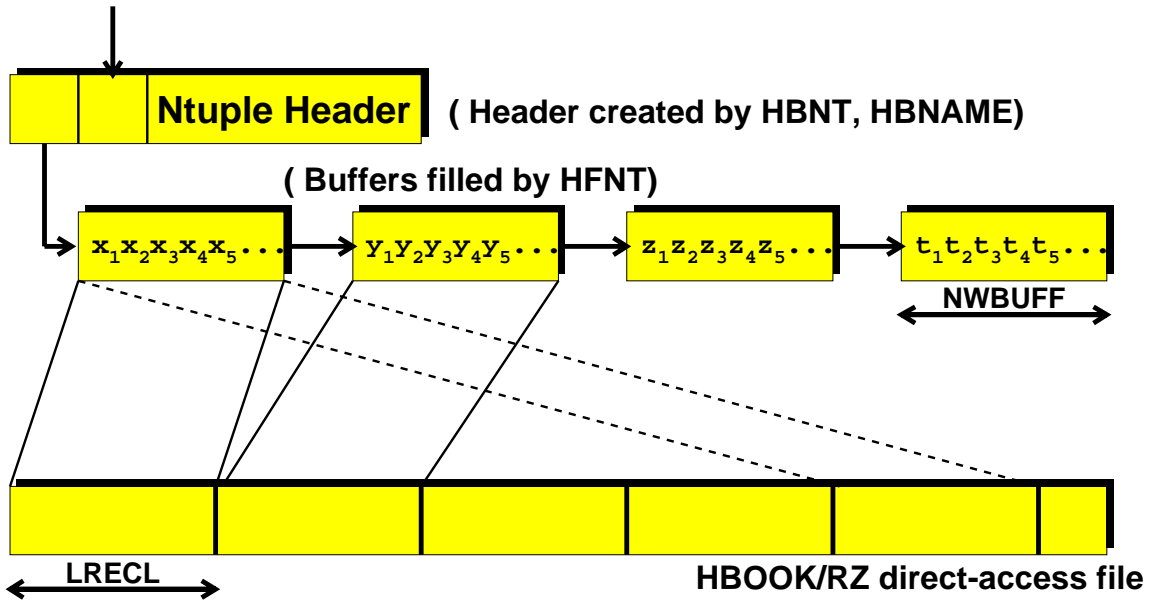

Figure 3.2: Schematic structure of a CWN Ntuple

Figure 3.2 shows the layout of a CWN Ntuple. The buffer size for each of the columns `NWBUFF` was set equal to the record length `LRECL` (defined with routine `HROPEN`). A CWN requires a large value for the length of the common `/PAWC/`, in any case larger than the number of columns times the value `NWBUFF`, i.e.  $NWPAWC > NWBUFF * NCOL$ . You can, however, expect important performance improvements by setting the buffer size `NWBUFF` equal to a multiple of the record length `LRECL` (via routine `HBSET`).

In both figures,  $x_i, y_i, z_i, t_i$ , etc. represent the columns of event  $i$ .

## 3.2 Row-Wise-Ntuples (RWN)

### 3.2.1 Booking a RWN

```
CALL HBOOKN (ID,CHTITL,NVAR,CHRZPA,NWBUFF,CHTAGS)
```

**Action:** Books a RWN in memory or with automatic overflow on an RZ file. Only single precision floating point numbers (REAL\*4 on 32 bit machines) can be stored, no data compression is provided.

#### Input parameters:

ID Identifier of the Ntuple.

CHTITL Character variable containing the title associated with the Ntuple.

NVAR Number of variables per event ( $NVAR \leq 512$ )

CHRZPA Character variable containing the path name of a RZ file onto which the contents of the Ntuple can overflow.

' ' **Memory resident Ntuples:**

A bank of NWBUFF words is created. Further banks of the same size are added in a linear chain should additional space be required at filling time.

'RZTOP' **Disk resident Ntuples:** (recommended)

A disk resident Ntuple is created if the CHRZPA argument specifies the top directory name of an existing RZ file that has already been opened with HROPEN or HRFILE. A bank of length NWBUFF is created, as in the case of memory resident Ntuples. However, each time the bank becomes full it is automatically flushed to the RZ file, rather than creating additional banks in memory.

NWBUFF Number of words for the primary allocation for the Ntuple.

CHTAGS Character array of length NVAR, providing a short name (up to eight characters) tagging scheme for each variable.

#### Example of the declaration of a memory resident RWN

```
CHARACTER*2 CHTAGS(5)
DATA CHTAGS/'Px','Py','Pz','Q2','NU'/
*
CALL HBOOKN(10,'My first NTUPLE',5,' ',1000,CHTAGS)
```

### 3.2.2 Filling a RWN

```
CALL HFN (ID,X)
```

**Action:** Fills a RWN.

#### Input parameters:

ID Identifier of the Ntuple.

X Array of dimension NVAR containing the values for the current event.

## Memory resident Ntuples

When a RWN is booked, HBOOK reserves space in memory in which to store the data, as specified by the NWBUFF argument of routine HBOOKN. As the RWN is filled by a call to HFN, this space will be successively used until full. At that time, a new memory allocation will be made and the process continues.

If this data is then written to disk, it appears as one enormous logical record. In addition, in most cases the last block of data will not be completely filled thus wasting space.

If one tries to reprocess this RWN at a later date, e.g. with PAW, there must be enough space in memory to store the entire Ntuple. This often gives rise to problems and so the following alternative method is recommended.

## Circular buffer

In an online environment you often want to have the last  $N$  events inside a buffer, so that the experiment can be monitored continuously. To make it easier to handle this case, you can use routine HFNOV, which fills a circular buffer in memory with RWN events, and when the buffer is full, overwrites the oldest Ntuple.

```
CALL HFNOV (ID,X)
```

**Action:** Fills a circular buffer with RWNs.

### Input parameters:

ID        Identifier of the Ntuple.  
X        Array of dimension NVAR containing the values for the current event.

## Disk resident Ntuples

Prior to booking the RWN, a new HBOOK RZ file is created using HROPEN. The top directory name of this file is passed to routine HBOOKN when the Ntuple is booked.

Filling proceeds as before but now, when the buffer in memory is full, it is written to the HBOOK file and then reused for the next elements of the Ntuple. This normally results in a more efficient utilisation of the memory, both when the Ntuple is created and when it is reprocessed.

### Recommended way of creating a RWN

```
PROGRAM TEST
PARAMETER (NWPWC = 15000)
COMMON/PAWC/PAW(NWPWC)
CHARACTER*8 CHTAGS(5)
DIMENSION EVENT(5)
EQUIVALENCE (EVENT(1),X),(EVENT(2),Y),(EVENT(3),Z)
EQUIVALENCE (EVENT(4),ENERGY),(EVENT(5),ELOSS)
DATA CHTAGS/'X','Y','Z','Energy','Eloss'/'
*
CALL HLIMIT(NWPWC)
CALL HROPEN(1,'EXAMPLE','EXAMPLE.DAT','N',1024,ISTAT)
IF(ISTAT.NE.0)GO TO 99
*
CALL HBOOKN(10,'A Row-Wise-Ntuple',5,'/EXAMPLE',5000,CHTAGS)
```

```

CALL HBOOK1(100,'Energy distribution',100,0.,100.,0.)
*
DO 10 I=1,10000
  CALL RANNOR(X,Y)
  Z=SQRT(X*X+Y*Y)
  ENERGY=50. + 10.*X
  ELOSS=10.*ABS(Y)
  CALL HFN(10,EVENT)
  CALL HFILL(100,ENERGY,0.,1.)
10 CONTINUE
*
CALL HROUT(0,ICYCLE,' ')
CALL HREND('EXAMPLE')
*
99 CONTINUE
END

```

When the Ntuple is filled, routine HFN will automatically write the buffer to the directory in the RZ file, which was specified in the call to HBOOKN (the top directory //EXAMPLE in the example above). If the current directory (CD) is different, HFN will save and later automatically restore the CD.

The Ntuple created by the program shown above can be processed by paw as follows.

#### Reading an RWN in a PAW session

```

PAW > Histo/file 1 example.dat
PAW > Histo/plot 100
PAW > Ntuple/plot 10.energy
PAW > Ntuple/plot 10.eloss energy<50
PAW > Ntuple/plot 10.eloss%energy x<2.and.sqrt(z)>1

```

By default HROPEN creates a file that can be extended up to 32000 blocks, i.e. 128 Mbytes for a record length LREC of 1024 words. If one wishes to create very large Ntuples, one should make two changes to the above procedure.

- A large value should be used for the record length of the file, e.g. 8192 words (the maximum on most machines). **N.B. the maximum record length on VMS systems is 8191 words. If access mode RELATIVE is used, the maximum is 4095 words.** This remark does not apply to a CWN, as described later.
- Option Q on HROPEN should be used to override the default number of records allowed.

This can be achieved as by changing the previous call to HROPEN as follows:

#### Writing very large Ntuple files

```

COMMON/QUEST/IQUEST(100)
CALL HLIMIT(150000)
*
* Create HBOOK file with the maximum record length (32756 bytes)
* and maximum number of records (65000)
*
IQUEST(10) = 65000
CALL HROPEN(1,'EXAMPLE','EXAMPLE.DAT','NQ',8192,ISTAT)
IF(ISTAT.NE.0)GO TO 99

```

### 3.3 More general Ntuples: Column-Wise-Ntuples (CWN)

A CWN supports the storage of the following data types: floating point numbers (REAL\*4 and REAL\*8), integers, bit patterns (unsigned integers), booleans and character strings.

#### Data Compression

Floating point numbers, integers and bit patterns can be packed by specifying a range of values or by explicitly specifying the number of bits that should be used to store the data. Booleans are always stored using one bit. Unused trailing array elements will not be stored when an array depends on an index variable. In that case only as many array elements will be stored as specified by the index variable.

For example, the array definition `NHITS(NTRACK)` defines `NHITS` to depend on the index variable `NTRACK`. When `NTRACK` is 16, the elements `NHITS(1..16)` are stored, when `NTRACK` is 3, only the elements one to three (`NHITS(1..3)`) are stored, etc.

#### Storage Model

Column wise storage allows direct access to any column in the Ntuple. Histogramming one column from a 300 column CWN requires reading only 1/300 of the total data set. However, this storage scheme requires one memory buffer per column as opposed to only one buffer in total for an RWN. By default the buffer length is 1024 words, in which case a 100 column Ntuple requires 409600 bytes of buffer space. In general, performance increases with buffer size. Therefore, one should tune the buffer size (using routine `HBSET`) as a function of the number of columns and the amount of available memory. Highest efficiency is obtained when setting the buffer size equal to the record length of the RZ HBOOK file (as specified in the call to `HROPEN`). A further advantage of column wise storage is that a CWN can easily be extended with one or more new columns.

Columns are logically grouped into blocks (physically, however, all columns are independent). Blocks allow users to extend a CWN with private columns or to group relevant columns together. New blocks can even be defined after a CWN has been filled. The newly created blocks can be filled using routine `HFNTB`. For example, a given experiment might define a number of standard Ntuples. These would be booked in a section of the code that would not normally be touched by an individual physicist. However, with a CWN a user may easily add one or more blocks of information as required for their particular analysis.

Note that arrays are treated as a single column. This means that a CWN will behave like a RWN, with the addition of data typing and compression, if only one array of `NVAR` elements is declared. This is not recommended as one thereby loses the direct column access capabilities of a CWN.

#### Performance

Accessing a relatively small number of the total number of defined columns results in a huge increase in performance compared to a RWN. However, reading a complete CWN will take slightly longer than reading a RWN due to the overhead introduced by the type checking and compression mechanisms and because the data is not stored sequentially on disk. The performance increase with a CWN will most clearly show up when using `PAW`, where one typically histograms one column with cuts on a few other columns. The advantages of having different data types and data compression generally outweighs the performance penalty incurred when reading a complete CWN.

### 3.3.1 Booking a CWN

The booking is performed in two stages. Firstly, a call to HBNT is made to declare the Ntuple identifier and title. Secondly, one or more calls are made to HBNAME or HBNAMC to describe the variables that are to be stored in the Ntuple. Routine HBNAMC is used to define CHARACTER variables, while all other variable types are defined with routine HBNAME.

```
CALL HBNT (ID,CHTITL,CHOPT)
```

**Action:** Books a CWN.

#### Input parameters:

ID            Identifier of the Ntuple.  
 CHTITL       Character variable specifying the title associated to the Ntuple.  
 CHOPT        Character variable specifying the desired options.  
               ' '     for disk resident Ntuples (default).  
               'D'    idem as ' ' .  
               'M'    for memory resident Ntuples.

The CWN will be stored in the current HBOOK directory. The variables to be stored in the Ntuple will be specified with routine HBNAME or HBNAMC described below.

When the CWN will be filled with HFNT, the memory buffers associated with each column will be written to the file and directory corresponding to the current working directory when HBNT was called. Remember that when routine HROPEN is called, the current working directory is automatically set to the top directory of that file. It is therefore convenient to call HBNT immediately after HROPEN. If this was not the case, routine HCDIR must be called prior to HBNT to set the current working directory. When the Ntuple has been filled (via calls to HFNT) the resident buffers in memory as well as the Ntuple header must be written to the file with a call to HROUT. Before calling HROUT, the current working directory must be set to the current directory when HBNT was called.

```
CALL HBSET (CHOPT,IVAL,IERR*)
```

**Action:** Set global Ntuple options.

#### Input parameters:

CHOPT        Character variable specifying the parameter to set.  
               'BSIZE'   Set the buffer size. For each variable (i.e. column) a buffer of BSIZE words is created in memory. The default for BSIZE is 1024.  
 IVAL         Value for the parameter specified with CHOPT.

#### Output parameters:

IERR         Error return code (=0 means no errors).



If the total memory in `/PAWC/`, allocated via `HLIMIT` is not sufficient to accommodate all the column buffers of `Bsize` words, then `HBNT` will automatically reduce the buffer size in such a way that all buffers can fit into memory. It is strongly recommended to allocate enough memory to `/PAWC/` in such a way that each column buffer is at least equal to the block size of the file. A simple rule of thumb in the case of no data compression is to have  $NWPAWC > NCOL * LREC$ , where `NWPAWC` is the total number of words allocated by `HLIMIT`, `LREC` is the block size of the file in machine words as given in the call to `HROPEN` and `NCOL` is the number of columns.

### 3.3.2 Describing the columns of a CWN

```
CALL HBNAME (ID, CHBLOK, VARIABLE, CHFORM)
```

```
CALL HBNAMEC (ID, CHBLOK, VARIABLE, CHFORM)
```

**Action:** Describe the variables to be stored in a CWN (non-character and character variables, respectively).

#### Input parameters:

**ID** Identifier of the Ntuple as in the call to `HBNT`.

**CHBLOK** Character variable of maximum length 8 characters specifying the name by which the block of variables described by `CHFORM` is identified.

**VARIABLE** The first variable that is described in `CHFORM`. Variables must be in common blocks but may not be in a ZEBRA bank. For example, given the common block `CEXAM` described below, one would call `HBNAME` with the argument `IEVENT`. In the case of character variables, the routine `HBNAMEC` must be used. In all other cases one should use `HBNAME`.

**CHFORM** Can be either a character string describing the variables to be stored in block `CHBLOK` or:

- '\$CLEAR' To clear the addresses of all variables in the Ntuple.
- '\$SET' To set the addresses in which to write the values of all variables in block `CHBLOK`.

The last two forms are used before reading back the Ntuple data using `HGNT`, `HGNTB`, `HGNTV` or `HGNTF`. See also `HUWFUN`.

With `CHFORM` the variables, their type, size and, possibly, range (or packing bits) can all be specified at the same time. **Note however that variable names should be unique, even when they are in different blocks.** In the simplest case `CHFORM` corresponds to the `COMMON` declaration. For example:

```
COMMON /CEXAM/ IEVENT, ISWIT(10), IFINIT(20), NEVENT, NRNDM(2)
```

can be described by the following `CHFORM`:

```
CHFORM = 'IEVENT, ISWIT(10), IFINIT(20), NEVENT, NRNDM(2)'
```

in this case the Fortran type conventions are followed and the default sizes are taken, no packing is done. Note that to get a nice one-to-one correspondance between the COMMON and the CHFORM statements the dimension of the variables are specified in the COMMON and not in a DIMENSION statement.

The default type and size of a variable can be overridden by extending the variable name with :<t>\*<s>:

<t>	type of variable	<s> values	default	routine
R	floating-point	4, 8	4	HBNAME
I	integer	4, 8	4	HBNAME
U	unsigned integer	4, 8	4	HBNAME
L	logical	4	4	HBNAME
C	character	[4<s<=32] (multiple of 4)	4	HBNAMEC

When the range of a type U, I or R variable is known, its storage size (number of packing bits) may be added behind the :<t>\*<s> specification using :<b> for types U and I and :<b>:[<min>,<max>] for type R. Floating-points are packed into an integer using:

$$IPACK = ((R - \text{<min>}) / (\text{<max>} - \text{<min>})) * (2^{**\text{<b>}} - 1) + 0.5$$

When :<b>... is not specified a variable is stored using the number of bytes given by <s> or the default. In case the default type and size of a variable should be used, the packing bits can be specified as ::<b>...<b> must be in the range  $1 \leq b \leq 8 * \text{<s>}$ . Automatic bit packing will happen, for type U and I, when a range is specified like: ICNT[-100,100]. In this case ICNT will be packed in 8 bits (7 bits for the integer part and 1 bit for the sign). In case CNT is an integer ranging from -100 to 100 it could be specified either like CNT[-100,100]:I or like CNT:I:[-100,100]. Logical variables will always be stored in 1 bit. All variables must be aligned on a word boundary and character variables must have a length modulo 4. The maximum length of the variable name is 32 characters.

Variable-length Ntuple rows and looping over array components are also supported to optimize Ntuple storage and Ntuple plotting. Variable row length can occur when arrays in the Ntuple depend on an index variable.

#### Example of a variable row length CWN definition

```

PARAMETER (MAXTRK = 100, MAXHIT = 300)
COMMON /CMTRK/ NTRACK, NHITS(MAXTRK), PX(MAXTRK), PY(MAXTRK),
+           PZ(MAXTRK), XHITS(MAXHIT,MAXTRK), YHITS(MAXHIT,MAXTRK),
+           ZHITS(MAXHIT,MAXTRK)
CALL HBNAME(ID,'VARBLOK2',NTRACK,
+          NTRACK[0,100], NHITS(NTRACK)[0,300], '//
+          PX(NTRACK), PY(NTRACK), PZ(NTRACK), XHITS(300,NTRACK), '//
+          YHITS(300,NTRACK), ZHITS(300,NTRACK)')

```

In this example the number of elements to store in one Ntuple row depends on the number of tracks, NTRACK. The call to HBNAME declares NTRACK to be an index variable and that the size of the Ntuple row depends on the value of this index variable. The range of an index variable is specified using [<l>,<u>], where <l> is the lower and <u> the upper limit of the arrays using this index variable. In the above example the lower limit of NTRACK is 0 and the upper limit is 100 (= MAXTRK). While filling a CWN HBOOK can also easily test for array out-of-bound errors since it knows the range of NTRACK. Only the last dimension of a multi-dimensional array may be variable and the index variable must be specified in the block where it is used. Array lower bounds must, just like the lower range of the index variable, be 0.

HBNAME may be called more than once per block as long as no data has been stored in the block. New blocks can be added to an Ntuple at any time, even after filling has started, whereas existing blocks may only be extended before filling has started.

**Alternative way of booking a CWN**

```
CALL HBOOKNC (ID,CHTITL,NVAR,BLOCK,TUPLE,CHTAGS)
```

**Action:** Provides a way to define a CWN similar to HBOOKN for a RWN.

**Input parameters:**

ID Identifier of the CWN. If it does not already exist, it is created.

CHTITL Character variable specifying the name of the Ntuple (not used if it already exists).

NVAR Number of variables per event (maximum 200).

BLOCK Name of the block inside the CWN(default is 'Block1').

TUPLE Array of dimension NVAR that will contain values at filling time.

CHTAGS Character array of length NVAR, providing a short name (up to eight characters) tagging scheme for each variable.

**3.3.3 Filling a CWN**

```
CALL HFNT (ID)
```

**Action:** Fill a CWN.

**Input parameter:**

ID Identifier of the CWN.

```
CALL HFNTB (ID,CHBLOK)
```

**Action:** Fill the named block CHBLOK in a CWN.

**Input parameters:**

ID Identifier of the Ntuple.

CHBLOK Character variable specifying the block that is to be filled.

```
CALL HPRNT (ID)
```

**Action:** Print the definition of the CWN ID as defined by the calls to HBNAME and/or HBNAMC.

**Input parameter:**

ID Identifier of the CWN.

## Recovery procedure

The Ntuple header, containing the essential definitions associated with an Ntuple, are now written to the output file when the first buffer is written. If the job producing the Ntuple does not terminate in a clean way (i.e. the job crashes or you forgot to call HROUT), it is now possible to rebuild the Ntuple header from the information available in the file. Note, however, that the events corresponding to the last Ntuple buffer in memory are lost.

```
CALL HRECOV (ID,CHOPT)
```

**Action:** Recover the information associated with a CWN.

### Input parameters:

ID            Identifier of the CWN.  
 CHOPT        Character variable specifying the option desired. At present Not used at present; ' ' should be specified

#### Example of saving contents of common variables in an Ntuple

```
COMMON/GCFLAG/IDEBUG, IDEMIN, IDEMAX, ITEST, IDRUN, IDEVT, IEORUN
+      , IEOTRI, IEVENT, ISWIT(10), IFINIT(20), NEVENT, NRNDM(2)

COMMON/GCTRAK/VECT(7), GETOT, GEKIN, VOUT(7), NMEC, LMEC(MAXMEC)
+      , NAMEC(MAXMEC), NSTEP, MAXNST, DESTEP, DESTEL, SAFETY, SLENG
+      , STEP, SNEXT, SFIELD, TOFG, GEKRAT, UPWGHT, IGNEXT, INWVOL
+      , ISTOP, IGAUTO, IEKBIN, ILOSL, IMULL, INGOTO, NLDOWN, NLEVIN
+      , NLVSAV, ISTORY

COMMON/GCTMED/NUMED, NATMED(5), ISVOL, IFIELD, FIELDM, TMAXFD, DMAXMS
+      , DEEMAX, EPSIL, STMIN, CFIELD, PREC, IUPD, ISTPAR, NUMOLD

CHARACTER*4 TYPE
COMMON/CMCC/TYPE

*   The code to book and fill the Ntuple would look like this:
*
*   Initialisation phase.
*   The calls to HROPEN, HBNT and HBNAME may be placed in different
*   initialisation routines.
*   In this example example the Ntuple will be stored in directory //MYFILE.
*
CALL HROPEN(1, 'MYFILE', 'geant.ntup', 'N', 1024, ISTAT)
CALL HBNT(10, 'Geant Ntuple', ' ')

*
CALL HBNAME(10, 'RUN', IDRUN, 'IDRUN::16, IDEVT::16')
CALL HBNAME(10, 'RUN', IEORUN, 'IEORUN::16')
CALL HBNAME(10, 'VECT', VECT, 'VECT(6)')
CALL HBNAME(10, 'GEKIN', GEKIN, 'GEKIN')
CALL HBNAME(10, 'INWVOL', INWVOL, 'INWVOL[1,7], ISTOP[1,7]')
CALL HBNAME(10, 'NUMED', NUMED, 'NUMED::10')
CALL HBNAME(10, 'NSTEP', NSTEP, 'NSTEP::16')
CALL HBNAME(10, 'TYPE', TYPE, 'TYPE:C')

*
```

```

*   To fill the Ntuple, when the common blocks are filled just invoke
*   routine HFNT which knows the addresses and the number of variables.
*
      DO 10 I = 1, 1000000
          ...
          CALL HFNT(10)
10    CONTINUE
*
*           At the end of the job, proceed as usual
*
      CALL HROUT(10, ICYCLE, ' ')
      CALL HREND('MYFILE')

```

## Disk resident Ntuples

Histograms are never created directly on a disk file. They are always created in the current directory in memory (//PAWC or //PAWC/subdir). Histograms are saved on the disk file with a call of type CALL HROUT. In case of disk-resident Ntuples, it is the same thing. The Ntuple header (data structure containing the column names) is always created in the current directory in memory (//PAWC or //PAWC/subdir). However, the call to HBNT remembers the current directory on disk (in the case below the CD on disk is //K0). When you fill the Ntuple, HFNT fills a buffer in memory. When this buffer is full, HFNT knows what is the CD on disk. The buffer is written into that directory. Note that your current directory on disk may be somewhere else. HFNT will temporarily change the CD to //K0 and will reset the CD to what it was before calling HFNT. At the end of your job, you have to save the header and the current buffer in memory on the disk file. For that you have to:

- Change the directory in memory where you book the ntuple. If you do not have subdirectories, this operation is not necessary.
- Change the directory on disk where you specified it in HBNT. In the case below //K0.
- Issue a call to HROUT or HREND.

### Creating a disk resident Ntuple

```

      call HCDIR('//PAWC',' ')
*--   HROPEN sets the directory to //K0, so no call to HCDIR is needed
      call HROPEN(50,'K0','~/mydir/K0.rz','N',1024,ISTAT)
      if (ISTAT.ne.0) write(6,*) 'Error in HROPEN'
      call HBNT(1000,'Ntuple','D')
      call HLDIR('//PAWC','T') ! Now you can see the header in //PAWC
      call HLDIR('//K0','T')  ! OK, nothing yet on //K0
*--   HBNAME describes the Ntuple
      call HBNAME(1000,'Event',EvtNo,
+           'RunNo:I,EvtNo:I,NPos:I,NNeg:I, '//
+           '....
.....
      call HLDIR('//K0','T') ! Nothing yet on //K0
      call HCDIR('//K0',' ') ! Useless, HFNT remembers that buffers are written to //K0
      call HFNT(1000)
      call HLDIR(' ','T')   ! This will not show anything on //K0.

```

```

! However if you call HLDIR(' ','TA') you will see all Ntuple
! extensions in the case you have many calls to HFNT.
! In this particular example everything is still in memory.
.....
call HCDIR('//K0',' ') ! Useless, you are already here
call HLDIR('//K0',' ') ! same as call hldir(' ','T')
call RZLDIR(' ',' ')
call HROUT(0,icycle,' ')
** If you call HLDIR(' ',' ') here you will see the header
** If you call HLDIR(' ','A') here you will see the header and your Ntuple extensions
call HREND('K0')

```

### 3.4 Making projections of a RWN

```
CALL HPROJ1 (ID, IDN, ISEL, FUN, IFROM, ITO, IVARX)
```

**Action:** Fill an existing one-dimensional histogram with data from a RWN.

#### Input parameters:

ID Identifier of 1-dimensional histogram, which must have been previously booked with HBOOK1.

IDN Identifier of the RWN Ntuple.

ISEL Selection flag

0 No selection criterion. Events between IFROM and ITO histogrammed with weight one.

<>0 Function FUN is called for each event between IFROM and ITP; they are histogrammed with a weight equal to the value of FUN.

FUN User function, to be declared EXTERNAL in the calling routine. It has as parameters the array of variables X and the selection flag ISEL. If FUN=0., no filling takes place for that event.

IFROM Event number where the histogramming has to start.

ITO Event number where the histogramming has to end.

IVARX Sequence number in the Ntuple of the variable to be histogrammed.

#### Example of the use of a one-dimensional Ntuple projection

```

PROGRAM MAIN
EXTERNAL WFUNC
CALL HPROJ1(10,20,1,WFUNC,0,0,4)
.....
FUNCTION WFUNC(X,ISEL)
DIMENSION X(*)
WFUNC=0.
IF (ISEL.EQ.1) THEN
    IF(X(2)**2 +X(3)**2.LT.0.)WFUNC=1.
ELSEIF (ISEL.EQ.2) THEN
    IF(X(2)**2 +X(3)**2.GT.5.)WFUNC=1.
ELSE
    WFUNC=X(5)
ENDIF
END

```

Note that in an interactive session with paw, the user function FUN can be defined interactively using a Fortran-like syntax without recompilation and relinking.

```
CALL HPROJ2 (ID, IDN, ISEL, FUN, IFROM, ITO, IVARX, IVARY)
```

**Action:** Same action as HPROJ1, but filling a previously booked 2-dimensional histogram or a profile histogram. Variable X(IVARX) will be projected onto the X axis and X(IVARY) onto the Y axis for all entries in the Ntuple between IFROM and ITO inclusive.

The number of entries in an Ntuple can be obtained by HNOENT.

### 3.5 Get information about an Ntuple

```
CALL HGIVEN (ID, CHTITL*, *NVAR*, CHTAG*, RLOW*, RHIGH*)
```

**Action:** Routine to provide information about an Ntuple.

#### Input parameters:

ID Identifier of the Ntuple.  
 NVAR Dimension of arrays TAGS, RLOW and RHIGH.

#### Output parameters:

CHTITL Character variable containing the title associated with the Ntuple.  
 NVAR The original contents is overwritten by the actual dimension of the Ntuple. If ID1 does not exist or is not an Ntuple NVAR=0 is returned.  
 CHTAG Character array of dimension NVAR, which contains the tag names of the Ntuple elements.  
 RLOW Array of dimension NVAR, which contains the lowest value for each Ntuple element.  
 RHIGH Array of dimension NVAR, which contains the highest value for each Ntuple element.

#### 3.5.1 Retrieve the contents of a RWN into an array

```
CALL HGN (ID, *IDN*, IDNEVT, X*, IERROR*)
```

**Action:** Copy the contents of a RWN event into an array.

#### Input parameters:

ID Identifier of the Ntuple.  
 IDN Must be initialized to zero before the first call to HGN.  
 IDNEVT Event number

#### Output parameters:

IDN Internal HBOOK pointer  
 X Array to contain variables for the event chosen.  
 IERROR Error return code.

This routine returns in the vector X the contents of the row IDNEVT or Ntuple ID. The vector X must be of size NVAR, as specified in the call to HBOOKN. If more than one row of the Ntuple is to be processed, it is more efficient to call first HGNPAR and then HGNF.

```
CALL HGNPAR (ID,CHROUT)
```

**Action:** Obtains the address and parameters of Ntuple ID.

**Input parameters:**

ID Identifier of the Ntuple.

CHROUT Character variable containing the name of the calling subroutine (printed in case of errors).

This routine sets some internal pointers and must be called before the first call to HGNF for a given RWN. When accessing more than one row of an Ntuple it is more efficient to call HGNPAR and then HGNF for each row that is required than to call HGN.

```
CALL HGNF (ID, IDNEVT, X*, IERROR*)
```

**Action:** Copy the contents of an Ntuple event into an array. The routine HGNPAR must have been called prior to the first call to HGNF for a given Ntuple.

**Input parameters:**

ID Identifier of the Ntuple.

IDNEVT Event number

**Output parameters:**

X Array to contain variables for the event chosen.

IERROR Error return code.

This routine returns in the vector X the contents of the row IDNEVT or Ntuple ID. The vector X must have be of size NVAR, as specified in the call to HBOOKN.

**Example of access to RWN information**

```
PROGRAM TEST
INTEGER NWPWC
PARAMETER (NWPWC=15000, MTUPLE=5)
COMMON/PAWC/PAW(NWPWC)
CHARACTER*80 CHTITL
CHARACTER*8 CHTAGS(MTUPLE),CHTAGZ(MTUPLE)
DIMENSION EVENT(MTUPLE),RLOW(MTUPLE),RHIGH(MTUPLE)
EQUIVALENCE (EVENT(1),X),(EVENT(2),Y),(EVENT(3),Z)
EQUIVALENCE (EVENT(4),ENERGY),(EVENT(5),ELOSS)
DATA CHTAGS/'X','Y','Z','Energy','Eloss'/
*-- Tell HBOOK how many words are in PAWC.
CALL HLIMIT(NWPWC)
*-- Book Ntuple
CALL HBOOKN(10,'A Row-Wise-Ntuple',5,' ',5000,CHTAGS)
*-- Fill the Ntuple
DO 10 I=1,1000
CALL RANNOR(X,Y)
Z=SQRT(X*X+Y*Y)
ENERGY=50. + 10.*X
ELOSS=10.*ABS(Y)
CALL HFN(10,EVENT)
10 CONTINUE
```



```

*-- Obtain the definitions of the Ntuple
   NVAR = MTUPLE
   CALL HGIVEN(10,CHTITL,NVAR,CHTAGZ,RLOW,RHIGH)
   PRINT *,'Definitions of Ntuple # ',10
   PRINT *,'  Title: ',CHTITL(1:LENOCC(CHTITL))
   PRINT *,'  Number of variables: ',NVAR
   DO 20 I=1,NVAR
     PRINT 9001,I,RLOW(I),RHIGH(I)
9001 FORMAT(' Min/Max values for column # ',I3,1X,F10.5,
+         1X,F10.5)
   20 CONTINUE
*-- Get the contents of 'event' # 333
   CALL HGMPAR(10,'TEST')
   CALL HGNF(10,333,EVENT,IERR)
   PRINT *,IERR,EVENT
*-- Get the number of events in this Ntuple
   CALL HNOENT(10,NEVENT)
   PRINT *,NEVENT
99 CONTINUE
END

```

### 3.5.2 Retrieve the contents of a CWN into a common block

```
CALL HGNT (ID,IDNEVT,IERR*)
```

#### Action:

Retrieve information about a CWN row.

#### Input parameters:

ID Identifier of the Ntuple.

IDNEVT Number of the event about which information is required.

#### Output parameter:

IERR Error return code (=0 if event was found)

The information is restored at the addresses specified by HBNAME or HBNAMEC (for CHARACTER data). If the information is being retrieved by a program other than the one that wrote the Ntuple then HBNAME or HBNAMEC must be called as appropriate (see below).

```
CALL HBNAME(ID,' ',0,'$CLEAR')
CALL HBNAME(ID,CHBLOK,VARIABLE,'$SET')
```

These calls are required as HBOOK must obtain the location at which the requested information is to be returned which is obviously not valid between programs. The first call clears all the addresses stored by HBOOK for the specified Ntuple and the second one sets the addresses for the variables in block CHBLOK starting at variable VARIABLE. The second call should be repeated for every block of which data has to be retrieved. The routine HUWFUN will generate these calls automatically in the skeleton user function.

```
CALL HGNTB (ID,CHBLOK,IROW,IERR*)
```

**Action:**

Retrieve information about a named block in an Ntuple row.

**Input parameters:**

ID Identifier of the Ntuple.  
 CHBLOK Character variable specifying the block that is to be retrieved.  
 IROW Number of the row about which information is required.

**Output parameter:**

IERR Error return code (=0 if row was found)

The information is restored at the addresses specified by HBNAME or HBNAMEC (for CHARACTER data).

```
CALL HGNTV (ID,CHVAR,NVAR,IROW,IERR*)
```

**Action:**

Retrieve information about the named variables in an Ntuple row.

**Input parameters:**

ID Identifier of the Ntuple.  
 CHVAR Array of character variables specifying the variables that are to be retrieved.  
 NVAR Number of character variables specified in CHVAR.  
 IROW Number of the row about which information is required.

**Output parameter:**

IERR Error return code (=0 if row was found)

The information is restored at the addresses specified by HBNAME or HBNAMEC (for CHARACTER data).

You should only call HBNAME for the blocks that contain variables you want to read using HGNTV. If you call HBNAME for all blocks you should have a PAWC which is at least the same size as the one you used to create the Ntuple. If not you will run out of memory.

Also changing the buffer size will not help because the buffer used for reading will be the same size as the buffer used to write the Ntuple.

There is a special option in HBNAME with which you can tell HBNAME to only set the address for a single variable in a block (this option is used by PAW to reduce memory usage).

To set the address for a single variable call HBNAME (or HBNAMEC) as follows:

```
CALL HBNAME(ID, BLOCK, IADDR, '$SET:NTVAR')
```

This will tell HGNTV to restore the Ntuple variable NTVAR in address IADDR. Using this form of HBNAME will only reserve buffer space for the variables you plan to read and not for all variables in the block. However, you have to be careful that when you change the list of variable for HGNTV to also add or remove the correct HBNAME calls.

```
CALL HGNTF (ID, IROW, IERR*)
```

**Action:**

Retrieve information about all variables specified in a previous call to either HGNT, HGNTB or HGNTV, in an Ntuple row. This routine is much faster than either HGNT, HGNTB or HGNTV.

**Input parameters:**

ID Identifier of the Ntuple.  
IROW Number of the row about which information is required.

**Output parameter:**

IERR Error return code (=0 if row was found)

The information is restored at the addresses specified by HBNAME or HBNAMC (for CHARACTER data).

```
CALL HNTVDEF (ID1, IVAR, CHTAG, BLOCK, ITYPE)
```

**Action:**

Returns the definition as given in HBNAME for the variable with index IVAR in Ntuple ID1. The Ntuple must already be in memory.

**3.5.3 Generate a user function**

HBOOK can automatically produce a skeleton user selection function, which includes the Ntuple declaration via the calls HBNT, HBNAME and HBNAMC, and can be used in a later run to access the elements of the Ntuple. Two cases are available; one for use in batch and the other for use with paw. In the first case the common block names will be those specified by the user in the call to HBNAME or HBNAMC. For paw, these common names are /PAWCR4/, /PAWCR8/ and /PAWCCH/ for storing the “single precision” (LOGICAL, INTEGER and REAL\*4), “double precision” (REAL\*8 and COMPLEX) and CHARACTER data respectively.

```
CALL HUWFUN (LUN, ID, CHFUN, ITRUNC, CHOPT)
```

**Action:**

Write an user function or subroutine to access an Ntuple.

**Input parameters:**

LUN Logical unit used to write the user routine. LUN must be opened before this call.  
ID Identifier of the Ntuple.  
CHFUN Character variable specifying the routine name.  
ITRUNC All variable names will be truncated to ITRUNC characters. ITRUNC=0 is no truncation.  
CHOPT Character variable specifying the desired options.  
    'B' Make an user subroutine for batch usage (i.e. with HBNAME and HBNAMC calls) (default).  
    'P' Make a paw selection function.

A simple example of the two kinds of skeletons generated with routine HUWFUN is given below. Another more complex example can be found on page 47, where the code of a fully worked out subroutine based on such a sketeton can also be studied.

In paw, the command UWFUNC generates a skeleton for the RWN or CWN analysis function automatically.

**Example of an Ntuple definition and HUWFUN usage**

```

COMMON /VECT/ V1, V2, V3, V4, V5, V6, V7, V8, V9, V10,
+           V11, V12, V13, V14, V15, V16, V17, V18, V19, V20
...
...
*
*-- book N-tuple 20
*
CALL HBNT(20,'1 block 20 variable N-tuple', ' ')
CALL HBNAME(20,'VECT',V1,'V1,V2,V3,V4,V5,V6,V7,V8,V9,V10,V11,
+           V12,V13,V14,V15,V16,V17,V18,V19,V20')
*
...
OPEN(11,FILE='nt20.f',STATUS='UNKNOWN')
OPEN(12,FILE='nt20p.f',STATUS='UNKNOWN')
CALL HUWFUN(11, 20, 'NT20', 0, 'B')
CALL HUWFUN(12, 20, 'NT20', 0, 'P')
...

```

The HUWFUN output files nt20.f and nt20p.f look like:

**File nt20.f**

```

SUBROUTINE NT20
*****
*
* This file was generated by HUWFUN.
*
*****
*
*   N-tuple Id:      20
*   N-tuple Title:  1 block 20 variable N-tuple
*   Creation:       11/06/92 18.46.10
*
*****
*
REAL V1,V2,V3,V4,V5,V6,V7,V8,V9,V10,V11,V12,V13,V14,V15,V16,V17
+ ,V18,V19,V20
COMMON /VECT/ V1,V2,V3,V4,V5,V6,V7,V8,V9,V10,V11,V12,V13,V14,V15
+ ,V16,V17,V18,V19,V20
*
CALL HBNAME(20,' ',0,'$CLEAR')
CALL HBNAME(20,'VECT',V1,'$SET')
*
*-- Enter user code here
*
*
END

```

```

File nt20p.f

REAL FUNCTION NT20()
*****
*
* This file was generated by HUWFUN.
*
*****
*
* N-tuple Id:      20
* N-tuple Title:  1 block 20 variable N-tuple
* Creation:       11/06/92 18.46.10
*
*****
*
COMMON /PAWIDN/ IDNEVT,VIDN1,VIDN2,VIDN3,VIDN(10)
*
REAL V1,V2,V3,V4,V5,V6,V7,V8,V9,V10,V11,V12,V13,V14,V15,V16,V17
+ ,V18,V19,V20
COMMON /PAWCR4/ V1,V2,V3,V4,V5,V6,V7,V8,V9,V10,V11,V12,V13,V14
+ ,V15,V16,V17,V18,V19,V20
*
*
*-- Enter user code here
*
NT20 = 1.
*
END

```

### 3.5.4 Optimizing event loops

`paw` is able, before starting the loop over the events, to find out which are the columns of the CWN which are actually referenced in any given query (command line selection expression or COMIS routine). Only the columns which are referenced will be read from the file.

If you analyse Ntuple data without `paw`, it is your own responsibility to find out and specify which are the columns referenced via the routines `HGNTV` or `HGNTB` (if all variables in a block are needed).

This optimization can be very important. Assume, for instance, that a 100 Mbyte file contains an Ntuple consisting of 300 columns, and that 3 columns are referenced. Then without optimization the complete 100 Mbyte file will have to be read, while, by specifying the columns used, only 1 Mbyte will be input.

### 3.6 Ntuple operations

#### Duplicate Ntuples

```
CALL HNTDUP (ID1, ID2, NEWBUF, CHTITL, CHOPT)
```

**Action:** Duplicate the definition of an Ntuple into a new Ntuple with the same definitions as the original one, but with 0 entries.

#### Input parameters:

ID1 Identifier of original Ntuple  
 ID2 Identifier of new Ntuple  
 NEWBUF Buffer size  
     NEWBUF<0 use buffer size of ID1  
     NEWBUF=0 use current buffer size(10000 for RWN's)  
     NEWBUF>0 use actually specified value as buffer size  
 CHTITL Character variable specifying the the new title for the duplicate Ntuple. If CHTITL=' ' use the original title.  
 CHOPT Character variable specifying the desired option  
     CHOPT=' ' use original value (disk or memory resident)  
     CHOPT='M' make the Ntuple memory resident  
     CHOPT='A' interactive mode: sets the addresses to /PAWCR4/.

#### Rename a column in an Ntuple

```
CALL HRENAME (ID1, CHOLD, CHNEW)
```

**Action:** Renames a column in an Ntuple. CHOLD of ntuple ID into CHNEW. Duplicate the definition of an Ntuple into a new Ntuple with the same definitions as the original one, but with 0 entries.

#### Input parameters:

ID1 Identifier of Ntuple  
 CHOLD Character variable with old column name  
 CHNEW Character variable with new column name

#### One-dimensional convolution of Ntuple

```
CALL HCONVOL (ID1, ID2, ID3, IERROR*)
```

**Action:** Perform a one-dimensional convolution of the Ntuple with respect to an other<sup>1</sup>. All histograms must pre-exist prior to calling this routine.

<sup>1</sup>Original code written by Per Steinar Iversen (PerSteinar.Iversen@fi.uib.no).

**Input parameters:**

- ID1 Ntuple identifier (this Ntuple can be 1-D or 2-D). It is used as kernel for the convolution of ID2.
- ID2 Ntuple to be convoluted
- ID3 Ntuple resulting from the convolution of ID2 with ID1

**Output parameters:**

- IERROR error return code.

**Discussion**

This method scales badly for large histograms. The best general algorithm would be to unpack the histograms, add a suitable number of zeros, do the two FFTs, multiply the transforms, do yet another FFT and stuff the resulting histogram back into HBOOK. However, for small histograms, the naive method is probably faster, especially if recoded in terms of lower level calls. It will also work with 1-D and 2-D kernel-histograms that do not have matched coordinate systems - the FFT method implies equal binsize in X and Y for the kernel and the histogram to be folded. This simple method uses HBOOK to avoid this in one (X) dimension at least, corresponding to folding in a constant resolution term.

**Example of use**

```

CALL HBOOK1(1,'Kernel 1 - 1D',100,-5.0,5.0,0.0)
CALL HBOOK2(2,'Kernel 2 - 2D',100,-5.0,5.0,100,0.0,100.0,0.0)
CALL HBPRO(2,0.0)
CALL HBOOK2(3,'Kernel 3 - 2D',100,-5.0,5.0,100,0.0,100.0,0.0)
CALL HBPRO(3,0.0)
CALL HBOOK1(4,'Function',100,0.0,100.0,0.0)
CALL HBOOK1(5,'Result 1',100,-10.0,110.0,0.0)
CALL HBOOK1(6,'Result 2',100,-10.0,110.0,0.0)
CALL HBOOK1(7,'Result 3',100,-10.0,110.0,0.0)

DO 10 I=1,100000
  CALL RANNOR(A,B)
  CALL HFILL(1,A,0.0,1.0)
  CALL HFILL(1,B,0.0,1.0)
  CALL RANNOR(A,B)
  CALL HFILL(2,A,100.0*RNDM(I),1.0)
  CALL HFILL(2,B,100.0*RNDM(I),1.0)
  CALL RANNOR(A,B)
  CALL HFILL(3,A,100.0*SQRT(RNDM(I+1)),1.0)
  CALL HFILL(3,B,100.0*SQRT(RNDM(I+1)),1.0)
  X = 30.0*(RNDM(I)-0.5)+50.0
  CALL HFILL(4,X,0.0,1.0)
10 CONTINUE

CALL HCONVOL(1,4,5,IERROR)
CALL HCONVOL(2,4,6,IERROR)
CALL HCONVOL(3,4,7,IERROR)

```

### 3.7 Ntuple examples

The first example shows the use of Row-Wise-Ntuples, containing only floating point data.

#### Creating and using a RWN

```

SUBROUTINE HEXAM7
*.,=====>
*.      Example of N-tuples.
*.,=====>
      DIMENSION X(3)
      CHARACTER*8 CHTAGS(3)
      DATA CHTAGS/' X ',' Y ',' Z '/
*.-----
*.
*      Reopen data base
*
      CALL HROPEN(1,'HEXAM7','hexam.dat','U',1024,ISTAT)
*
      CALL HBOOK1(10,'TEST1',100,-3.,3.,0.)
      CALL HBOOK2(20,'TEST2',20,-3.,3.,20,-3.,3.,250.)
      CALL HBOOKN(30,'N-TUPLE',3,'//HEXAM7,1000,CHTAGS)
*
      DO 10 I=1,10000
          CALL RANNOR(A,B)
          X(1)=A
          X(2)=B
          X(3)=A*A+B*B
          CALL HFN(30,X)
10  CONTINUE
*
      CALL HROUT(30,ICYCLE,' ')
      CALL HPROJ1(10,30,0,0,1,999999,1)
      CALL HPROJ2(20,30,0,0,1,999999,1,2)
      CALL HPRINT(0)
*
      CALL HROUT(10,ICYCLE,' ')
      CALL HROUT(20,ICYCLE,' ')
*
      CALL HLDIR(' ',' ')
*
      CALL HREND('HEXAM7')
      CLOSE (1)
*
      END

```





TEST2

HBOOK ID = 20 DATE 17/12/91 NO = 21

```

CHANNELS 10 U 0      1      2 0
          1 N 12345678901234567890 V
          *****
OVE      *      ++22 3+  +      * OVE
2.7     *      + ++233+3+6 ++ +      * 20
2.4     *      + +396353325+3+ +      * 19
2.1     *      ++2288EBCB89852 + 2      * 18
1.8     *      +23+5B7HJIKC8552++      * 17
1.5     *      + + 525CTJY*WQWUF864+2      * 16
1.2     *      +78BRX*****WVF8532      * 15
.9      *      2 328DS*****K72      * 14
.6      *      + 9+6IY*****RGA22 2      * 13
.3      *      378LU*****VI563 2      * 12
          *      + 43ARX*****TPC63 2      * 11
- .3    *      + 3IQZ*****UFB53 3      * 10
- .6    *      + 298PY*****SIB83 +      * 9
- .9    *      65JS*****QKE55      * 8
- 1.2   *      + 4358MT*****M863 +      * 7
- 1.5   *      + 3 3AIS*****QFF7+4+      * 6
- 1.8   *      44ADKQZYX*YPG942++      * 5
- 2.1   *      +4334BELLKNE7F66+++      * 4
- 2.4   *      + + 327598C7943672+3      * 3
- 2.7   *      + 23467382+2      * 2
- 3     *      2 ++++332+42      * 1
UND     *      ++2 +++++ 2      * UND
          *****

```

LOW-EDGE

```

-----
1. 3222111      111222
0  07418529630369258147

```

```

*
* ENTRIES = 10000      PLOT      I 11 I
* SATURATION AT= 255      I-----I-----
* SCALE .,+,2,3,.,., A,B,      STATISTICS      10 I 9957 I 11
* STEP = 1.00      * MINIMUM=0.000      I-----I-----
* I 11 I

```

```

*****
* NTUPLE ID= 30 ENTRIES= 10000 N-TUPLE
*****
* Var numb * Name * Lower * Upper *
*****
* 1 * X * -.359595E+01 * 0.396836E+01 *
* 2 * Y * -.398909E+01 * 0.381000E+01 *
* 3 * Z * 0.748417E-03 * 0.162475E+02 *
*****

```

==&gt; Directory :

```

30 (N) N-TUPLE
10 (1) TEST1
20 (2) TEST2

```

### A more complex example - CERN personnel statistics

In order to explain the advantages of the Column-Wise-Ntuple format, we consider a small data sample containing some characteristics of the CERN staff as they were in 1988. For each member of the staff there exists one entry in the file. Each entry consists of 11 values, as described in the following table:

Variable Name	Description and possible values
<b>CATEGORY:</b>	Professional category (integer between 100 and 600) <b>100-199:</b> Scientific staff <b>200-299:</b> Engineering staff <b>300-399:</b> Technical support staff <b>400-499:</b> Crafts and trade support staff <b>500-529:</b> Supervisory administrative staff <b>530-559:</b> Intermediate level administrative staff <b>560-599:</b> Lower level administrative staff
<b>DIVISION:</b>	Code for each division (Character variable) 'AG', 'DD', 'DG', 'EF', 'EP', 'FI', 'LEP', 'PE', 'PS', 'SPS', 'ST', 'TH', 'TIS'
<b>FLAG:</b>	A flag where the first four bits have the following significance Bit 1 = 0 means <b>female</b> otherwise <b>male</b> Bit 2 = 0 means <b>resident</b> otherwise <b>non-resident</b> Bit 3 = 0 means <b>single</b> otherwise <b>head of family</b> Bit 4 = 0 means <b>fixed term contract</b> otherwise <b>indefinite duration contract</b>
<b>AGE:</b>	Age (in years) of staff member
<b>SERVICE:</b>	Number of <b>years of service</b> that the staff member has at CERN
<b>CHILDREN:</b>	Number of <b>dependent children</b>
<b>GRADE:</b>	Staff member 's position in <b>Grade</b> scale (integer between 3 and 14)
<b>STEP:</b>	Staff member 's position (step) <b>inside</b> given grade (integer between 0 and 15)
<b>NATION:</b>	Code for staff member 's <b>nationality</b> (character variable) 'AT', 'BE', 'CH', 'DE', 'DK', 'ES', 'FR', 'GB', 'GR', 'IT', 'NL', 'NO', 'PT', 'SE', 'ZZ'
<b>HRWEEK:</b>	Number of contractual <b>hours worked per week</b> (between 20 and 44)
<b>COST:</b>	<b>Cost</b> of the staff member to CERN (in CHF)

Note how the constraints on the various variables shown in the table are expressed in the job when creating the Ntuple.

On the next pages we show first the creation run, together with its output and the automatically generated analysis skeleton, and then the analysis program created based on the skeleton.

---

**Creating the Ntuple**

---

```

PROGRAM CERN

PARAMETER (NWPAWC = 30000)
PARAMETER (LRECL = 1024)

COMMON /PAWC/ IPAW(NWPAWC)

REAL   RDATA(11)
INTEGER CATEGORY, FLAG, AGE, SERVICE, CHILDREN, GRADE, STEP,
+      HRWEEK, COST
CHARACTER*4  DIVISION, NATION
COMMON /CERN/ CATEGORY, FLAG, AGE, SERVICE, CHILDREN, GRADE,
+      STEP, HRWEEK, COST
COMMON /CERN/ DIVISION, NATION

CHARACTER*4 DIVS(13), NATS(15)
DATA DIVS /'AG', 'DD', 'DG', 'EF', 'EP', 'FI', 'LEP', 'PE',
+      'PS', 'SPS', 'ST', 'TH', 'TIS'/
DATA NATS /'AT', 'BE', 'CH', 'DE', 'DK', 'ES', 'FR', 'GB',
+      'GR', 'IT', 'NL', 'NO', 'PT', 'SE', 'ZZ'/

CALL HLIMIT(NWPAWC)

*
*-- open a new RZ file
*
      CALL HROPEN(1, 'MYFILE', 'cern.hbook', 'N', LRECL, ISTAT)

*
*-- book Ntuple
*
      CALL HBNT(10, 'CERN Population', ' ')

*
*-- define Ntuple (1 block with 11 columns)
*
      CALL HBNAME(10, 'CERN', CATEGORY, 'CATEGORY[100,600]:I,
+      FLAG:U:4, AGE[1,100]:I, SERVICE[0,60]:I,
+      CHILDREN[0,10]:I, GRADE[3,14]:I, STEP[0,15]:I,
+      HRWEEK[20,44]:I, COST:I')
      CALL HBNAMC(10, 'CERN', DIVISION, 'DIVISION:C, NATION:C')

*
*-- open data file with staff information
*
      OPEN(2, FILE='aptuple.dat', STATUS='OLD')

```

```

*
*-- read data and store in Ntuple
*
10  READ(2, '(10F4.0, F7.0)', END=20) RDATA
*
    CATEGORY = RDATA(1)
    DIVISION = DIVS(INT(RDATA(2)))
    FLAG     = RDATA(3)
    AGE      = RDATA(4)
    SERVICE  = RDATA(5)
    CHILDREN = RDATA(6)
    GRADE    = RDATA(7)
    STEP     = RDATA(8)
    NATION   = NATS(INT(RDATA(9)))
    HRWEEK   = RDATA(10)
    COST     = RDATA(11)
    CALL HFNT(10)
    GOTO 10

*
*-- read data of person #100
*
20  I = 100
    CALL HGNT(10, I, IER)
    IF (IER .NE. 0) THEN
        PRINT *, 'Error reading row ',I
    ENDIF
    PRINT *, 'Person 100', ' ',CATEGORY,' ',DIVISION,' ',AGE,' ',NATION

*
*-- print Ntuple definition
*
    CALL HPRNT(10)

*
*-- write batch version of analysis routine to file staff.f
*
    OPEN(3, FILE='staff.f', STATUS='UNKNOWN')
    CALL HUWFUN(3, 10, 'STAFF', 0, 'B')

*
*-- write Ntuple buffer to disk and close RZ file
*
    CALL HROUT(10, ICYCLE, ' ')
    CALL HREND('MYFILE')

*
    END

```

---

**Output generated by running the above program**

```

**** ERROR in HFNT : HRWEEK: Value out of range, event      2668 : ID=      10
**** ERROR in HFNT : HRWEEK: Value out of range, event      2673 : ID=      10
**** ERROR in HFNT : HRWEEK: Value out of range, event      2710 : ID=      10
**** ERROR in HFNT : HRWEEK: Value out of range, event      2711 : ID=      10
**** ERROR in HFNT : HRWEEK: Value out of range, event      2833 : ID=      10
Person 100 415 PS      55 FR

```

```

*****
* Ntuple ID = 10      Entries = 3354      CERN Population      *
*****
* Var numb * Type * Packing *      Range      * Block * Name *
*****
*      1 * I*4 *      11 * [100,600] * CERN * CATEGORY *
*      2 * U*4 *      4 *      *      * CERN * FLAG *
*      3 * I*4 *      8 * [1,100] * CERN * AGE *
*      4 * I*4 *      7 * [0,60] * CERN * SERVICE *
*      5 * I*4 *      5 * [0,10] * CERN * CHILDREN *
*      6 * I*4 *      5 * [3,14] * CERN * GRADE *
*      7 * I*4 *      5 * [0,15] * CERN * STEP *
*      8 * I*4 *      7 * [20,44] * CERN * HRWEEK *
*      9 * I*4 *      *      *      * CERN * COST *
*     10 * C*4 *      *      *      * CERN * DIVISION *
*     11 * C*4 *      *      *      * CERN * NATION *
*****
* Block * Unpacked Bytes * Packed Bytes * Packing Factor *
*****
* CERN *      44 *      19 *      2.316 *
* Total *      44 *      19 *      2.316 *
*****
* Number of blocks = 1      Number of columns = 11 *
*****

```

Note the HFNT error messages, which report that out-of-range data were read in the input file. This is an example of the error checking performed by the CWN routines.

**Analysis skeleton generated for above example**

```

SUBROUTINE STAFF
*****
*
* This file was generated by HUWFUN.
*
*****
*
*      N-tuple Id:      10
*      N-tuple Title:  CERN Population
*      Creation:      12/06/92 11.46.34
*
*****
*
INTEGER CATEGORY,FLAG,AGE,SERVICE,CHILDREN,GRADE,STEP,HRWEEK,COST
CHARACTER DIVISION*4,NATION*4
COMMON /CERN/ CATEGORY,FLAG,AGE,SERVICE,CHILDREN,GRADE,STEP,HRWEEK

```

```

+ ,COST
COMMON /CERN1/ DIVISION,NATION
*
CALL HBNAME(10,' ',0,'$CLEAR')
CALL HBNAME(10,'CERN',CATEGORY,'$SET')
CALL HBNAMC(10,'CERN',DIVISION,'$SET')
*
*-- Enter user code here
*
*
END

```

This skeleton is used in the example below to prepare a job for analysing the Ntuple data sample.

#### Example of Fortran code based on skeleton

```

PROGRAM NEWNTUP

PARAMETER (NPPAWC = 30000)
PARAMETER (LRECL = 1024)
COMMON /PAWC/ IPAW(NPPAWC)

CALL HLIMIT(NPPAWC)
CALL HROPEN(1,'MYFILE','cern.hbook',' ',LRECL,ISTAT)
CALL HRIN(10,9999,0)
CALL STAFF
CALL HREND('MYFILE')
END
SUBROUTINE STAFF
*****
*
* This file was generated by HUWFUN.
*
*****
*
* N-tuple Id: 10
* N-tuple Title: CERN Population
* Creation: 12/06/92 11.46.34
*
*****
*
INTEGER CATEGORY,FLAG,AGE,SERVICE,CHILDREN,GRADE,STEP,HRWEEK,COST
COMMON /CERN/ CATEGORY,FLAG,AGE,SERVICE,CHILDREN,GRADE,STEP,HRWEEK
+ ,COST

CHARACTER DIVISION*4,NATION*4
COMMON /CERN1/ DIVISION,NATION
*
CHARACTER*8 VAR(4)
*
CALL HBNAME(10,' ',0,'$CLEAR') ! Clear addresses in Ntuple
CALL HBNAME(10,'CERN',CATEGORY,'$SET') ! Set addresses for variables CATEGORY...
CALL HBNAMC(10,'CERN',DIVISION,'$SET') ! Set addresses for variables DIVISION...
*

```

```

*-- Enter user code here
*
*-- book the histograms
*
    CALL HBOOK1(101, 'Staff Age', 45, 20., 65., 0.)
    CALL HBOOK1(102, 'Number of years at CERN', 35, 0., 35., 0.)
    CALL HBOOK2(103, 'Grade vs. Step', 12, 3., 15., 16, 0., 16., 0.)
    CALL HBIGBI(101,2)
    CALL HBIGBI(102,2)
*
*-- get number of entries
*
    CALL HNOENT(10, NLOOP)
*
*-- read only the four desired columns
*
    VAR(1) = 'AGE'
    VAR(2) = 'SERVICE'
    VAR(3) = 'GRADE'
    VAR(4) = 'STEP'
    CALL HGNTV(10, VAR, 4, 1, IER)
    DO 10 I = 1, NLOOP
      IF (I.NE.1) CALL HGNTF(10, I, IER)
      IF (IER .NE. 0) THEN
        PRINT *, 'Error reading row ', I
      ENDIF
      CALL HFILL(101, FLOAT(AGE), 0., 1.)
      CALL HFILL(102, FLOAT(SERVICE), 0., 1.)
      CALL HFILL(103, FLOAT(GRADE), FLOAT(STEP), 1.)
10  CONTINUE
*
    CALL HISTDO
*
    END

```

The summary table about the Ntuple shown below, as obtained by running the program above on the CERN Ntuple, should be compared with the table obtained during the creation run, as shown on page 46.

#### Output Generated

HBOOK	HBOOK	CERN	VERSION	4.17	HISTOGRAM AND PLOT INDEX						09/03/93
NO	TITLE		ID	B/C	ENTRIES	DIH	NCHA	LOWER	UPPER	ADDRESS	LENGTH
1	CERN Population		10			N				27174	37
2	Staff Age		101	32	3354	1 X	45	.200E+02	.650E+02	26527	90
3	Number of years at CERN		102	32	3354	1 X	35	.000E+00	.350E+02	26432	83
4	Grade vs. Step		103	32	3354	2 X Y	12 16	.300E+01 .000E+00	.150E+02 .160E+02	26347 26074	298 264

MEMORY UTILISATION

MAXIMUM TOTAL SIZE OF COMMON /PAWC/            30000



```

*****
* Ntuple ID = 10      Entries = 3354      CERN Population  *
*****
* Var num * Type * Packing *      Range      * Block * Name *
*****
* 1 * I*4 * 11 * [100,600] * CERN * CATEGORY *
* 2 * U*4 * 4 * [1,100] * CERN * FLAG *
* 3 * I*4 * 8 * [0,60] * CERN * AGE *
* 4 * I*4 * 7 * [0,60] * CERN * SERVICE *
* 5 * I*4 * 5 * [0,10] * CERN * CHILDREN *
* 6 * I*4 * 5 * [3,14] * CERN * GRADE *
* 7 * I*4 * 5 * [0,15] * CERN * STEP *
* 8 * I*4 * 7 * [20,44] * CERN * HRWEEK *
* 9 * I*4 * * * * CERN * COST *
* 10 * C*4 * * * * CERN * DIVISION *
* 11 * C*4 * * * * CERN * NATION *
*****
* Block * Unpacked Bytes * Packed Bytes * Packing Factor *
*****
* CERN * 44 * 19 * 2.316 *
* Total * 44 * 19 * 2.316 *
*****
* Blocks = 1      Variables = 11      Columns = 11 *
*****

Staff Age

HBOOK      ID =      101      DATE 09/03/93      NO =      1

180      --
176      II
172      II--
168      -- I I
164      II I I--
160      -- II I I
156      II II-- I I
152      II-- I I--
148      I I I
144      I I I
140      I I I
136      I I I
132      I I I
128      --I I II
124      I I --II
120      I I I--I
116      -- --I I
112      II I I--
108      II I I
104      II I I
100      --II I I
96      I I--I I
92      I I I---
88      I I I
84      I I I
80      --I I I
76      I I I
72      I I I
68      I I I
64      ----I I
60      I I I
56      I I I
52      I I I
48      II-- -- ----I
44      I I --II I
40      -- I I--I I I
36      II--I I--I I
32      I I I
28      I I I--
24      I I I
20      ----I I
16      --I I I
12      I I I
8      ----I I
4      ----I I

CHANNELS  10 0      1      2      3      4
1 1 2 3 4 5 6 7 8 9 0 1 2 3 4 5 6 7 8 9 0 1 2 3 4 5 6 7 8 9 0 1 2 3 4 5

CONTENTS 100
10      1 1 1 1 1 1 1 1 1 1 1 1 1 1 1 1 1 1 1 1 1 1 1 1
1.      1 1 7 6 5 8 8 8 3 9 5 9 2 5 3 7 6 4 4 9 0 4 3 3 8 8 1 8 4 9 2 2 2 7 2 0 2 2 9 1 1 9 5 2

LOW-EDGE 10 2 2 2 2 2 2 2 2 2 3 3 3 3 3 3 3 3 4 4 4 4 4 4 4 4 4 4 5 5 5 5 5 5 5 5 5 6 6 6 6 6
1. 0 1 2 3 4 5 6 7 8 9 0 1 2 3 4 5 6 7 8 9 0 1 2 3 4 5 6 7 8 9 0 1 2 3 4 5 6 7 8 9 0 1 2 3 4

* ENTRIES =      3354      * ALL CHANNELS = .3354E+04      * UNDERFLOW = .0000E+00      * OVERFLOW = .0000E+00
* BIN WID = .1000E+01      * MEAN VALUE = .4765E+02      * R . H . S = .8643E+01

```

```

Number of years at CERN
HBOOK ID = 102 DATE 09/03/93 NO = 2

200
195 -- --
190 II II I
185 II I I
180 II--I I
175 II I I
170 II I I
165 II -- I I--
160 II II I I
155 II II I I
150 II II I I-- II
145 II II I I II
140 II--II I I--II
135 I I I
130 I I--I I
125 I I II
120 --I I--II
115 I I
110 I I--
105 II I
100 II I
95 II I
90 II I
85 II -- II I
80 II II I
75 II II I
70 II II I
65 -- II II I
60 II II II I
55 II --II II -- I
50 II I I II II I
45 --II--I I II --II I
40 I I--I I I I I
35 I I I I I --I
30 I I I I I I
25 I I--I I--I I I
20 I I I
15 I I I
10 I I--I I

```

```

CHANNELS 10 0 1 2 3 4 5 6 7 8 9 0 1 2 3 4 5 6 7 8 9 0 1 2 3 4 5 6 7 8 9 0 1 2 3 4 5
1 1 2 3 4 5 6 7 8 9 0 1 2 3 4 5 6 7 8 9 0 1 2 3 4 5 6 7 8 9 0 1 2 3 4 5

CONTENTS 100 1 1 1 1 1 1 1 1 1 1 1 1 1 1 1 1 1 1 1 1 1 1 1 1 1 1 1 1 1 1 1 1
10 4 6 4 4 5 0 2 4 8 2 4 5 3 1 7 3 6 2 9 7 9 9 6 4 3 5 2 2 1 5 5 4 7 1
1. 3 5 2 1 4 9 1 0 9 3 5 5 7 2 8 8 6 5 9 5 7 8 2 4 6 7 2 0 9 0 2 2 7 2 4

LOW-EDGE 10 1 1 1 1 1 1 1 1 1 1 1 1 1 1 1 1 1 1 1 1 1 1 1 1 1 1 1 1 1 1 1 1
1. 1 2 3 4 5 6 7 8 9 0 1 2 3 4 5 6 7 8 9 0 1 2 3 4 5 6 7 8 9 0 1 2 3 4

```

```

* ENTRIES = 3354 * ALL CHANNELS = .3349E+04 * UNDERFLOW = .0000E+00 * OVERFLOW = .5000E+01
* BIN MID = .1000E+01 * MEAN VALUE = .1943E+02 * R . H . S = .8124E+01

```

```

Grade vs. Step
HBOOK ID = 103 DATE 09/03/93 NO = 3

```

```

CHANNELS 10 U 0 1 0
1 N 123456789012 V
*****
OVE * * OVE
15 * 4* * 16
14 * 7 * 15
13 * 22***** * 14
12 * +J*YFB23G * 13
11 * 39**QJ6H8 * 12
10 * 3C*YTL6JE* * 11
9 * 36E**N9HD3 * 10
8 * 2K**VEN85 * 9
7 * +38D***NRB25 * 8
6 * 26Q***TD8 * 7
5 * 3S9***UH7+ * 6
4 * 5I9P*QKG44 * 5
3 * 298W*QK72 * 4
2 * +9J*S*HK5 + * 3
1 * 7EJHYQH6+ * 2
* 32A9GHH2 * 1
UND * * UND
*****

```

```

LOW-EDGE 10 1111
1. 345678901234

```

```

* ENTRIES = 3354 PLOT -----I-----I-----
* SATURATION AT= INFINITY I 3354 I
* SCALE .+,2,3,..., A,B, STATISTICS -----I-----I-----
* STEP = 1.00 * MINIHUH=0.000E+00 I I

```

## Chapter 4: Advanced features for booking and editing operations

### 4.1 Overview of booking options

#### 4.1.1 Histograms with non-equidistant bins

```
CALL HBOOK (ID,CHTITL,NCX,XBINS,VMX)
```

**Action:** As HBOOK1, but instead of giving the lower and upper limits, an array XBINS of NCX+1 elements is provided.

XBINS (1) contains the lower edge of the first bin.  
XBINS (2) contains the lower edge of the second bin.  
... and so on.  
XBINS (NCX+1) contains the upper edge of the last bin.

#### 4.1.2 Profile histograms

```
CALL HBPROF (ID,CHTITL,NCX,XLOW,XUP,YMIN,YMAX,CHOPT)
```

**Action:** Create a profile histogram. Profile histograms are used to display the mean value of Y and its RMS for each bin in X. Profile histograms are in many cases an elegant replacement of two-dimensional histograms : the inter-relation of two measured quantities X and Y can always be visualized by a two-dimensional histogram or scatter-plot; its representation on the line-printer is not particularly satisfactory, except for sparse data. If Y is an unknown (but single-valued) approximate function of X, this function is displayed by a profile histogram with much better precision than by a scatter-plot.

The following formulae show the cumulated contents (capital letters) and the values displayed by the printing or plotting routines (small letters) of the elements for bin J.

$$\begin{aligned} H(J) &= \sum Y & E(J) &= \sum Y^2 \\ l(J) &= \sum l & L(J) &= \sum l \\ h(J) &= H(J)/L(J) & s(J) &= \sqrt{E(J)/L(J) - h(J)^2} \\ e(J) &= s(J)/\sqrt{L(J)} \end{aligned}$$

The first five parameters are similar to HBOOK1. Only the values of Y between YMIN and YMAX will be considered. To fill a profile histogram, one must use CALL HFILL (ID,X,Y,1.).

H(J) is printed as the channel contents. The errors displayed are s(J) if CHOPT='S' (spread option), or e(J) if CHOPT=' ' (error on mean).

Profile histograms can be filled with weights.

The computation of the errors and the text below is based on a proposal by Stephane Coutu<sup>1</sup>.

If a bin has N data points all with the same value Y (especially possible when dealing with integers), the spread in Y for that bin is zero, and the uncertainty assigned is also zero, and the bin is ignored in making subsequent fits. This is a problem. If  $\sqrt{Y}$  was the correct error in the case above, then  $\sqrt{Y}/\sqrt{N}$  would be

---

<sup>1</sup>Stephane Coutu, coutu@roo.physics.lsa.umich.edu

the correct error here. In fact, any bin with non-zero number of entries  $N$  but with zero spread should have an uncertainty  $\sqrt{Y}/\sqrt{N}$ .

Yet, is  $\sqrt{Y}/\sqrt{N}$  really the correct uncertainty? Probably it is only true in the case where the variable  $Y$  is some sort of counting statistics, following a Poisson distribution. This should probably correspond to the default case. However,  $Y$  can be any variable from an original Ntuple, not necessarily distributed according to a Poisson distribution. Therefore several settings for the option variable `CHOPT` are possible to determine how errors should be calculated ( $S$  stands for the spread in the formulae below):

' ' (Default)      Errors are     $S/\sqrt{N}$     for  $S \neq 0$ .,  
                       "        "         $\sqrt{Y}/\sqrt{N}$     for  $S = 0, N > 0$ ,  
                       "        "        0.            for  $N = 0$ .

'S'                Errors are     $S$         for  $S \neq 0$ .,  
                       "        "         $\sqrt{Y}$        for  $S = 0, N > 0$ ,  
                       "        "        0.         for  $N = 0$ .

'I'                Errors are     $S/\sqrt{N}$     for  $S \neq 0$ .,  
                       "        "         $1./\sqrt{12.N}$     for  $S = 0, N > 0$ ,  
                       "        "        0.            for  $N = 0$ .

The third case above corresponds to integer  $Y$  values for which the uncertainty is  $\pm 0.5$ , with the assumption that the probability that  $Y$  takes any value between  $Y - 0.5$  and  $Y + 0.5$  is uniform (the same argument goes for  $Y$  uniformly distributed between  $Y$  and  $Y + 1$ ); this could be useful, for instance, for the case where  $Y$  are ADC measurements.

### 4.1.3 Rounding

```
CALL HBINSZ ('YES'/'NO')
```

**Action:** Round the bin size for bookings of subsequent histograms to a reasonable value, i.e.: 1., 1.5, 2., 2.5, 4., 5. times an integer power of 10. `HBINSZ` controls a switch that, when on, rounds the binsize, still respecting the number of bins. The switch is initially off.

#### Input parameters:

'YES'            enable the 'reasonable rounding' feature.  
 'NO'            disable the 'reasonable rounding' feature.

### 4.1.4 Projections, Slices, Bands

```
CALL HBPRO (ID,VMX)
```

**Action:** Books the projections of a 2-dimensional histogram as two 1-dimensional histograms.

#### Input parameters:

ID	identifier of an existing 2-dimensional histogram ID=0 means book projections for all existing 2-dimensional histograms.
VMX	upper limit of single channel content.

**Remark:**

- if ID does not exist, or is a 1-dimensional histogram, the call does nothing
- see HB00K1 for details about VMX
- booking of projections can be executed only after the 2-dimensional histogram with identifier ID has been booked.

```
CALL HBPROX (ID,VMX) and CALL HBPROY (ID,VMX)
```

**Action:** Books projection onto X or Y only. See HBPR0 for more details.

```
CALL HBANDX (ID,YMI,YMA,VMX)
```

**Action:** Books a projection onto X, restricted to the Y interval (YMI ,YMA).

**Input parameters:**

ID	identifier of an existing 2-dimensional histogram
YMI	lower limit of Y interval
YMA	upper limit of Y interval
VMX	maximum value to be stored in 1 channel.

The same remarks as for HBPR0 apply.

```
CALL HBANDY (ID,XMI,XMA,VMX)
```

**Action:** As HBANDX but the projection is onto Y.

```
CALL HBSLIX (ID,NSLI,VMX)
```

**Action:** Books slices along Y of 2-dimensional histograms as NSLI 1-dimensional histograms. Each slice is a projection onto X restricted to an interval along the Y axis.

**Input parameters:**

ID	identifier of an existing 2-dimensional histogram
NSLI	number of slices
VMX	maximum value to be stored in 1 channel.

The same remarks as for HBPR0 apply.

```
CALL HBSLIY (ID,NSLI,VMX)
```

**Action:** As HBSLIX but slices are projected onto Y.

### 4.1.5 Statistics

Mean value and standard deviation of 1-dimensional histograms are calculated at editing time, using the channel contents. If a more accurate calculation is desired, or if more statistical information is needed, the following option will provide it : `CALL HIDOPT (ID, 'STAT')`

```
CALL HBARX (ID)
```

**Action:** Store the errors for 1-dimensional histograms, X-projections, etc., in memory and superimpose them on the plot during output. This routine must be called after booking **but before filling**.

**Input parameter:**

ID identifier of an existing histogram. ID=0 means all histograms already booked.

If ID corresponds to a 2-dimensional histogram, HBARX acts on all X projections, slices, bands.

$$\text{Error}(i) = \sqrt{\sum_{j=1}^{n^i} W_{ji}^2} \quad \text{where :} \quad \begin{array}{ll} i & \text{bin number} \\ n^i & \text{number of entries in bin } i \\ W_{ji} & \text{weight of event } j \text{ in bin } i \end{array}$$

It is clear that the sum of the squares of weights in each bin must also be stored to perform this calculation. However when filling with weight always equal to 1, errors can be calculated from bin contents only, and HBARX, HBARY need not be called. The superimposition of error bars can be selected at output time, using `HIDOPT(ID, 'ERR0')` In both cases the values of errors can be printed under the contents, via the editing option `HIDOPT(ID, 'PERR')` The entry HPAKE permits user-defined error bar setting.

```
CALL HBARY (ID)
```

**Action:** As HBARX, it is used to act on Y projections of 2-dimensional histograms.

```
CALL HBAR2 (ID)
```

**Action:** This routine can be used to create the data structure to store errors for 2-D histograms (like HBARX for 1-Ds). By default, the errors are set to the `sqrt(contents)`.

**Input parameter:**

ID identifier of an existing 2-D histogram. ID=0 means all histograms already booked.

The routine HPAKE (or the `paw` command `PUT/ERR`) may be used to fill errors. If HBAR2 is not called before HPAKE, then HPAKE invokes HBAR2 automatically. When HBAR2 is called, routines `HFILL` or `HF2` will accumulate the sum of the squares of the weights. The errors for 2-D histograms are used by the fit routines or the `Histo/FIT` command. The error bars are not drawn by the `hplot` routines.

### 4.1.6 Function Representation

```
CALL HBFUN1 (ID,CHTITL,NX,XMI,XMA,FUN)
```

**Action:** Books 1-dimensional histogram and fills it with the values of the external function  $FUN(X)$  computed at the centre of each bin. One computer word per channel is used.

The first five parameters are as for HBOOK1.

#### Input parameters:

ID	histogram identifier, integer non zero
CHTITL	histogram title (character variable or constant up to 80 characters)
NX	number of channels
XMI	lower edge of first channel
XMA	upper edge of last channel
FUN	real function of one variable, to be declared EXTERNAL in the calling subroutine, and to be supplied by the user.

```
CALL HBFUN2 (ID,CHTITL,NX,XMI,XMA,NY,YMI,YMA,FUN)
```

**Action:** Books a 2-dimensional histogram and fills it with the values of the external function  $FUN(X, Y)$ , computed at the centre of each bin. One computer word per channel is used.

The first eight parameters are as for HBOOK2.

#### Input parameters:

ID	histogram identifier, integer
CHTITL	histogram title (character variable or constant up to 80 characters)
NX	number of channels in X
XMI	lower edge of first X channel
XMA	upper edge of last X channel
NY	number of channels in Y
YMI	lower edge of first Y channel
YMA	upper edge of last Y channel
FUN	real function of two variables, to be declared EXTERNAL in the calling subroutine, and to be supplied by the user.

```
CALL HFUNC (ID,FUN)
```

**Action:** Samples the function  $FUN$ , which must have been declared EXTERNAL, at the centre of the bins of a histogram. The function will be superimposed onto the histogram at editing time and its values optionally printed out (see  $HIDOPT(ID, 'PFUN')$ )

**Input parameters:**

ID	identifier of an existing 1-dimensional histogram. ID=0 signals that the function should be calculated for all existing 1-dimensional histograms.
FUN	External real function, e.g. REAL FUNCTION FUN(X). The function parameter X will be the central value of a histogram bin. The user must return the corresponding function at that point as a value in FUN.

**Remark:**

- Not existing for 2-dimensional histograms.
- Function FUN cannot contain any call to an entry of the HBOOK package.
- HFUNC can be called several times for the same histogram identifier ID. In the latter case, the values of the old function will be overwritten by the new one.
- The chi-squared  $\chi^2$ , as defined below, will be printed along with the statistical information at the bottom of the histogram.

$$\chi^2 = \sum_{i=1}^{n_{ch}} \frac{(C(i) - F(i))^2}{\sum_{j=1}^{n^i} W_{ji}^2}$$

with:  $n_{ch}$  number of channels of histogram  
 $C(i)$  contents of channel  $i$   
 $F(i)$  value of function at centre of channel  $i$   
 $n^i$  number of entries in channel  $i$   
 $W_{ji}$  weight of event  $j$  in channel  $i$ , i.e.  
square root of contents  $C(i)$  or  
as given by HBARX/HPAKE

**4.1.7 Reserve array in memory**

```
CALL HARRAY (ID,NWORDS,LOC*)
```

**Action:** Reserves an array in the memory storage area managed by HBOOK.

**Input parameters:**

ID	identifier of the array (pseudo-histogram)
NWORDS	length of the array.

**Output Parameters**

LOC	Address minus one in the internal hbook common block /PAWC/ of the 1st element of the array, i.e.
-----	---

```
COMMON/PAWC/NWPAW,IXPAWC,IHDIV,IXHIGZ,IXKU,FENC(5),LMAIN,HCV(9989)
DIMENSION IQ(2),Q(2),LQ(8000)
EQUIVALENCE (LQ(1),LMAIN),(IQ(1),LQ(9)),(Q(1),IQ(1))

IADDR = Q(LOC+1)
```

**Remark:**

At any time the address of pseudo-histogram ID can be obtained with HLOCAT(ID,LOC)



### 4.1.8 Axis labels and histograms

A set of routines, HLABEL, HFC1 and HFC2, allows one to associate labels with histogram channels. This association can be made before or after a histogram is filled, but it has the advantage that the label information get stored in the histogram data structure, so that it is available for all future plots in an automatic way in the H PLOT and PAW packages. Printing histograms with associated alphanumeric labels is not implemented in the line-printer oriented routines of HBOOK.

```
CALL HLABEL (ID,NLAB,*CLAB*,CHOPT)
```

**Action:** Associates alphanumeric labels with a histogram. This routine can be called for a histogram after it has been filled, and then the labels specified will be shown on the respective axes. The routine can also be called before a histogram is filled, and in this case, when filling, a certain order can be imposed. By default the entries will be automatically ordered.

#### Input parameters:

ID Histogram identifier.

NLAB Number of labels.

CHOPT Character variable specifying the option desired.

- ' ' As 'N' below.
- 'N' Add NLAB new labels read in CLAB to histogram ID.
- 'R' Read NLAB labels into in CLAB from histogram ID.
- 'X' X-axis is being treated (default).
- 'Y' Y-axis is being treated.
- 'Z' Z-axis is being treated.
- 'S' Sorting order of the labels:
  - 'S' default, as 'SA';
  - 'SA' alphabetically;
  - 'SE' reverse alphabetical order;
  - 'SD' by increasing channel contents (after filling);
  - 'SV' by decreasing channel contents (after filling).
- 'T' Modify (replace) NLAB existing labels read from CLAB in histogram ID.

#### Input/Output parameter:

\*CLAB\* Character variable array with NLAB elements (input and output).

Notes:

- For one-dimensional histograms HLABEL can be called at any time.
- For two-dimensional histograms one **must** call HLABEL with option 'N' for each axis between the call to HB00K2 and the first call to HFC2.

## 4.2 Filling Operations

It is possible to speed up the filling process with the loss of some protection, and to globally transfer an array or a matrix to a histogram.

### 4.2.1 Fast Filling Entries

If the program that is using HBOOK fills many histograms several times a substantial fraction of time can be spent by HFILL in searching for the histogram it has to fill, deciding which type of histogram it is and unpacking and packing bits if more than one channel is to be stored in one computer word. To reduce the overall filling time, there are several actions that can be taken

- Bypass part of the logic that finds out the characteristics of the histogram to fill. This can be achieved by using, instead of HFILL the special filling entries described in this section.
- Avoid packing more than one channel in a computer word.

For these reasons it is recommended to use always HFILL at the development stage, and replace it later with HF1, HF2, etc. only when a rather stable program is going to be used extensively.

Calls to HFILL and HF1 or HF2 cannot be mixed on the same ID.

```
CALL HF1 (ID,X,WEIGHT)
```

**Action:** Analogous to HFILL on a 1-dimensional histogram but HBARX and HIDEOPT(ID, 'STAT') are ignored.

#### Input parameters:

ID        histogram identifier  
X         value of the abscissa  
WEIGHT   event weight

```
CALL HF1E (ID,X,WEIGHT,ERRORS)
```

**Action:** Analogous to HF1, but also the errors are accumulated.

#### Input parameters:

ID        histogram identifier.  
X         value of the abscissa.  
WEIGHT   the content is incremented by WEIGHT.  
ERROR     the error is incremented by ERROR\*\*2.

====ζ HF1E Fills a 1-D histogram

SUBROUTINE HF1E(ID,X,W,E)

- ID : Histogram identifier. - X : Value of the abscissa - W : Content is incremented by W - E : Errors is incremented by E\*\*2

```
CALL HF2 (ID,X,Y,WEIGHT)
```

**Action:** Analogous to HFILL on a 2-dimensional histogram except that projections, bands, slices are not filled. HBARY is ignored as well.

**Input parameters:**

ID histogram identifier  
 X value of the abscissa  
 Y value of the ordinate  
 WEIGHT event weight

```
CALL HFF1 (ID,*NID*,X,WEIGHT)
```

**Action:** Analogous to HF1 with the same restrictions. Cannot be used for variable-bin-width histograms.

**Input parameters:**

ID histogram identifier  
 NID is a histogram-specific variable that has to be provided by the user.  
 Before the first call, NID must be initialized to 0.  
 In subsequent calls to HFF1 the constant NID must then be used in order to skip the calculation of the histogram address.  
 X value of the abscissa  
 WEIGHT event weight

**Output parameter:**

NID After the first call to HFF1, NID will contain the current address of histogram ID.

```
CALL HFF2 (ID,*NID*,X,Y,W)
```

**Action:** Analogous to HF2 with the use of the parameter NID as explained for HFF1.

```
CALL HFPAK1 (ID,NID,V,N)
```

**Action:** Fill an histogram using the contents of a vector.

**Input parameters:**

ID histogram identifier  
 V array containing the values to be entered into the histogram.  
 N length (dimension) of the array V

**Input/output parameter:**

\*NID\* address of histogram (see HFF1)

This subroutine has the same effect as

```
DO 10 I=1,N
10 CALL HFF1(ID,NID,V(I),1.)
```

where the array V of N words must have been filled previously by the user.

```
CALL HIPAK1 (ID,NID,IV,N)
```

**Action:** Analogous to HFPK1, except that the user vector contains now integers instead of real numbers.

### 4.2.2 Global Filling

A vector or matrix can be transferred into a histogram with a single call.

```
CALL HPAK (ID,CONTEN)
```

**Action:** Transfer the contents of an array as channel contents into an histogram. The original contents of the histogram are overwritten.

#### Input parameters:

ID            an existing histogram identifier  
 CONTEN      a user array, suitably dimensioned

#### Remark:

- In the case of a **1-dimensional** histogram, the dimension of the array must at least be equal to the number of histogram channels (NCHAN), i.e. DIMENSION CONTEN(NX) with  $NX > NCHAN$
- In the case of a **2-dimensional** histogram, the dimensions of the array must exactly be equal to the number of histogram channels (NCHANX and NCHANY), i.e. DIMENSION CONTEN(NX, NY) with  $NX = NCHAN$  and  $NY = NCHANY$   
 Projections and slices, if present for the given histogram, are **not** filled.

```
CALL HPAKAD (ID,CONTEN)
```

**Action:** Similar to HPAK, but instead of overwriting the channel contents, the array values are **added** to the respective channel contents.

```
CALL HPAKE (ID,ERRORS)
```

**Action:** Store the contents of an array as the errors for the bins of the 1-dimensional histogram for which the option HBARX has been invoked.

#### Input parameters:

ID            histogram identifier  
 ERRORS      user array containing the errors to be assigned to the histogram bin contents. Its dimension should be at least equal to the number of channels in histogram ID.

#### Remark:

If the HBARX option was not set for the given histogram, then it is activated by a call to HPAKE.

### 4.2.3 Filling histograms using character variables

Routines for which, using routine HLABEL, alphanumeric labels were associated with the histogram channels, are filled with the routines HFC1 and HFC2. These allow, on top of by bin number, to fill an histogram by specifying a alphanumeric channel identifier.

```
CALL HFC1 (ID, IBIN, CLAB, W, CHOPT)
```

**Action:** Fills a channel in a one-dimensional histogram.

ID      One-dimensional histogram identifier.  
 IBIN    Number of the bin to be filled (if  $\neq 0$ ).  
 CLAB    Character variable containing the label describing the bin (if IBIN=0).  
 CHOPT   Character variable specifying the option desired.  
       ' '    default, as 'S';  
       'N'    filling order, i.e. the order of the labels on the plot is given by the sequence in which they are presented in the successive calls to the routine (this method can be very time consuming since all channels must be scanned at each call);  
       'S'    automatic sort;  
       'U'    if the channel does not exist then the underflow channel is incremented (by default a new channel is created for each new label).

**Remarks:**

- If IBIN $\neq$ 0, then the channel IBIN is filled; CLAB may then be undefined.
- When a label is encountered, which is not yet known, then for options 'N' and 'S' a new channel is added dynamically, while for option 'U' the underflow channel is incremented.
- Routine HLABEL can be called before or after HFC1.

```
CALL HFC2 (ID, IBINX, CLABX, IBINY, CLABY, W, CHOPT)
```

**Action:** Fills for a two-dimensional histogram the channel identified by position IBINX or label CLABX and position IBINY or label CLABY with weight W.

ID      Two-dimensional histogram identifier.  
 IBINX   Number of the X-bin to be filled (if  $\neq 0$ ).  
 CLABX   Character variable containing the label describing the X-bin (if IBINX=0).  
 IBINY   Number of the Y-bin to be filled (if  $\neq 0$ ).  
 CLABY   Character variable containing the label describing the Y-bin (if IBINY=0).  
 W        Weight of the event to be entered into the histogram.  
 CHOPT   Character variable specifying the option desired.  
       ' '    default, as 'S';

- 'N' filling order (see HFC1;
- 'S' automatic sort (default)
- 'U' if the channel does not exist then the underflow channel is incremented (by default a new channel is created for each new label).

**Remarks:**

- For efficiency reasons, routine HLABEL must be called **before** HFC2.
- If  $IBINX \neq 0$ , then the channel described by IBINX is filled; CLABX may then be undefined.
- If  $IBINY \neq 0$ , then the channel described by IBINY is filled; CLABY may then be undefined.
- If the channel described by IBINX or CLABX does not exist, the underflow channel is incremented. Idem for IBINY and CLABY.

The example below shows different uses of the label routines. The input data are the same as those used for building the Ntuple on page 43. Three histograms are booked. For the first one (1 1), the number of channels (13) is given explicitly, and a call to HLABEL declares all the labels for that histogram. Then a second histogram (12) is booked with one pre-declared channel. In fact this latter histogram will be filled with HFC1, in a way completely identical to histogram 1 1, but channels will be dynamically added as new labels are encountered. We also create a 2-D histogram (21), where for the y-axis we again pre-declare labels and we fill it with a call to HFC2. After the loop, where the histograms are filled, we tell HBOOK to order the labels in the second histogram (12) according to decreasing bin contents. This shows that it is not necessary, in the 1-D case, to pre-declare the labels of a histogram, but that they can be added to a histogram “on the fly”, i.e. while filling. The sorting order can be specified after the histogram is filled. As stated earlier, labels are only printed on graphical output devices, so that one must use H PLOT/HIGZ to see the effect of the label routines. The calls to the H PLOT/HIGZ routines, used to generate the PostScript picture shown in Fig. 4.1, are described in the HIGZ/H PLOT manual.

---

**Example of the use of the histogram label routines**

---

```

PROGRAM CERN

PARAMETER (NWPAWC = 30000)
COMMON /PAWC/ IPAW(NWPAWC)
REAL      RDATA(11)
CHARACTER*4 CHDIV,CHDIVS(13), CHNAT,CHNATS(15)

DATA CHDIVS /'AG', 'DD', 'DG', 'EF', 'EP', 'FI', 'LEP', 'PE',
+          'PS', 'SPS', 'ST', 'TH', 'TIS'/
DATA CHNATS /'AT', 'BE', 'CH', 'DE', 'DK', 'ES', 'FR', 'GB',
+          'GR', 'IT', 'NL', 'NO', 'PT', 'SE', 'ZZ'/

CALL HLIMIT(NWPAWC)
*
OPEN(11,FILE='aptuple.dat', STATUS='OLD')
OPEN(12,file='hlabexa.ps',form='formatted',status='unknown')

CALL HBOOK1(11,'Example HLABEL explicit list',13,1.,14.,0.)
CALL HBOOK1(12,'Example HLABEL implicit list',1,0.,1.,0.)
CALL HBOOK2(21,'Example HLABEL 2-D',13,2.,15.,13,1.,14.,0.)
*
CALL HLABEL(11,13,CHDIVS,'N')
CALL HLABEL(21,13,CHDIVS,'NY')
*
*-- Loop over input data
*
DO 10 IEVENT = 1, 99999
  READ(11, '(10F4.0, F7.0)', END=20) RDATA
  CHDIV   = CHDIVS(INT(RDATA(2)))
  IGRADE  = RDATA(7)
  CALL HFC1(11,0,CHDIV,1.,' ')
  CALL HFC1(12,0,CHDIV,1.,' ')
  CALL HFC2(21,IGRADE,' ',0,CHDIV,1.,' ')
10 CONTINUE

20 CALL HLABEL(12,0,' ', 'SV')
*
*-- Call the HPLLOT/HIGZ routines to print the histos showing the labels
*
CALL HPLINT(0)
CALL HPLCAP(-12)
CALL HPLSET('VSIZ',0.20)
CALL HPLSET('NDVX',-13.05)
CALL HPLSET('HCOL',1105)
CALL HPLSET('BCOL',1.5)
CALL HPLSET('*FON',-60.)
CALL HPLOPT('NBOX',1)
CALL HPLZON(2,2,1,' ')
CALL HPLLOT(11,' ', ' ',0)
CALL HPLLOT(12,' ', ' ',0)
CALL HPLZON(1,2,2,'S')
CALL HPLOPT('GRID',1)
CALL HPLLOT(21,'BOX', ' ',0)
CALL HPLEND
*
END

```

---

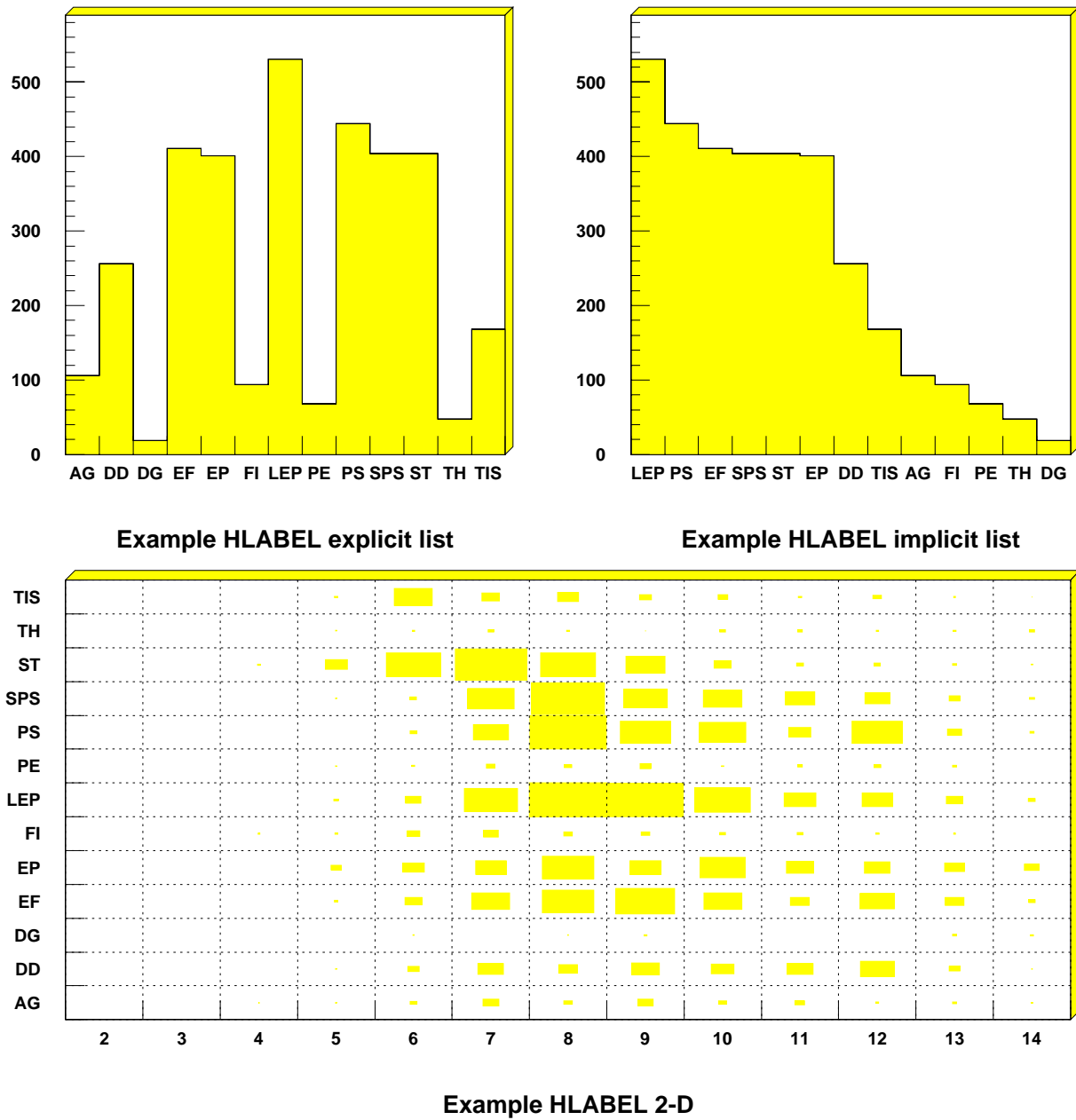

Figure 4.1: Example of the use of HLABEL

- The top left picture shows the contents of the histogram ordered alphabetically by label.
- The top right picture shows the same histogram, but with the bins ordered by decreasing contents, irrespective of their label.
- The lower picture shows a two-dimensional histogram, where the ordinate (Y-axis) ordered alphabetically.



<b>Example of booking options</b>
-----------------------------------

```

SUBROUTINE HEXAM2
* .=====>
* .          TEST OF SOME BOOKING OPTIONS USING HBOOK RANDOM
* .          NUMBER GENERATORS.
* .=====> ( R.Brun )
COMMON/HDEXF/C1,C2, XM1, XM2, XS1, XS2
DOUBLE PRECISION C1, C2, XM1, XM2, XS1, XS2
EXTERNAL HTFUN1, HTFUN2
* .-----
* .
* .          Booking
* .
C1=1.
C2=0.5
XM1=0.3
XM2=0.7
XS1=0.07
XS2=0.12
*
CALL HBFUN1(100, 'TEST OF HRNDM1', 100, 0., 1., HTFUN1)
CALL HIDOPT(100, 'STAR')
CALL HCOPY(100, 10, ' ')
*
CALL HBOOK1(110, 'THIS HISTOGRAM IS FILLED ACCORDING TO THE FUNCT
+ION HTFUN1'
+ , 100, 0., 1., 1000.)
*
CALL HBFUN2(200, 'TEST OF HRNDM2', 100, 0., 1., 40, 0., 1., HTFUN2)
CALL HSCALE(200, 0.)
CALL HCOPY(200, 20, ' ')
*
CALL HBOOK2(210, 'HIST FILLED WITH HFILL AND HRNDM2', 100, 0., 1.,
+ 40, 0., 1., 30.)
*
* .          Filling
* .
DO 10 I=1, 5000
X=HRNDM1(100)
CALL HFILL(110, X, 0., 1.)
CALL HRNDM2(200, X, Y)
CALL HFILL(210, X, Y, 1.)
10 CONTINUE
*
* .          Save all histograms on file 'hexam.dat'
* .
CALL HRPUT(0, 'hexam.dat', 'N')
*
CALL HDELET(100)
CALL HDELET(200)
*
* .          Printing
* .
CALL HPRINT(0)
END
FUNCTION HTFUN1(X)
DOUBLE PRECISION HDFUN1

```

```
HTFUN1=HDFUN1(X)
END
FUNCTION HTFUN2(X,Y)
HTFUN2=HTFUN1(X)*HTFUN1(Y)
END
DOUBLE PRECISION FUNCTION HDFUN1(X)
COMMON/HDEXF/C1,C2, XM1, XM2, XS1, XS2
DOUBLE PRECISION C1,C2, XM1, XM2, XS1, XS2, A1, A2, X1, X2
*
A1=-0.5*((X-XM1)/XS1)**2
A2=-0.5*((X-XM2)/XS2)**2
IF(A1.LT.-20.)THEN
  X1=0.
ELSEIF(A1.GT.20.)THEN
  X1=1.E5
ELSE
  X1=C1*EXP(A1)
ENDIF
IF(A2.LT.-20.)THEN
  X2=0.
ELSEIF(A2.GT.20.)THEN
  X2=1.E5
ELSE
  X2=C2*EXP(A2)
ENDIF
HDFUN1=X1+X2
END
```

---









<b>More booking examples</b>
------------------------------

```

SUBROUTINE HEXAM3
* .=====>
* .      MORE BOOKING OPTIONS
* ..=====> ( R.Brun )
*
*           Get all histograms saved in example 2
*
CALL HROPEN(1,'HEXAM','hexam.dat','U',1024,ISTAT)
CALL HRIN(0,9999,0)
CALL HMDIR('HEXAM3','S')
*
*           Print an index of all histograms that are now in memory
*
CALL HINDEX
*
*           Reset hist 110 and 210.  adds more options
*
CALL HRESET(110,' ')
CALL HRESET(210,' ')
CALL HIDOPT(110,'STAT')
CALL HBARX(210)
CALL HBPROX(210,0.)
CALL HBSLIX(210,3,1000.)
CALL HBANDY(210,0.1,0.5,0.)
CALL HIDOPT(0,'1EVL')
*
*           New filling
*
DO 10 I=1,2000
  CALL HFILL(110,HRNDM1(10),0.,1.)
  CALL HRNDM2(20,X,Y)
  CALL HFILL(210,X,Y,1.)
10 CONTINUE
*
*           Print new contents using specialized printing routines
*           Same result could be obtained using HISTDO/HPRINT(0)/HPS.
*
CALL HPHIST(110,'HIST',1)
CALL HPSCAT(210)
CALL HPHIST(210,'PROX',1)
CALL HPHIST(210,'BANY',1)
CALL HPHIST(210,'SLIX',0)
*
*           Save all histograms in new directory HEXAM3
*
CALL HROUT(0,ICYCLE,' ')
CALL HREND('HEXAM')
CLOSE (1)
*
END

```

Output Generated

HBOOK	HBOOK	CERN	VERSION	4.13	HISTOGRAM AND PLOT INDEX					17/12/91			
NO	TITLE				ID	B/C	ENTRIES	DIH	NCHA	LOWER	UPPER	ADDRESS	LENGTH
1	TEST OF HRNDH1				100	32	-1 1 X	100	0.000E+00	0.100E+01	64912	146	
2	TEST OF HRNDH1				10	32	100 1 X	100	0.000E+00	0.100E+01	64764	146	
3	THIS HISTOGRAM IS FILLED ACCORDING TO THE FUNCTION HTFUN1				110	10	5000 1 X	100	0.000E+00	0.100E+01	64605	89	
4	TEST OF HRNDH2				200	32	-1 2 X Y	100 40	0.000E+00 0.000E+00	0.100E+01 0.100E+01	64523 60218	4328 4296	
5	TEST OF HRNDH2				20	32	4000 2 X Y	100 40	0.000E+00 0.000E+00	0.100E+01 0.100E+01	60193 55888	4328 4296	
6	HIST FILLED WITH HFILL AND HRNDH2				210	5	5000 2 X Y	100 40	0.000E+00 0.000E+00	0.100E+01 0.100E+01	55858 55123	763 726	

MEMORY UTILISATION

MAXIMUM TOTAL SIZE OF COMMON /PAWC/ 80000

THIS HISTOGRAM IS FILLED ACCORDING TO THE FUNCTION HTFUN1

HBOOK ID = 110 DATE 17/12/91 NO = 1

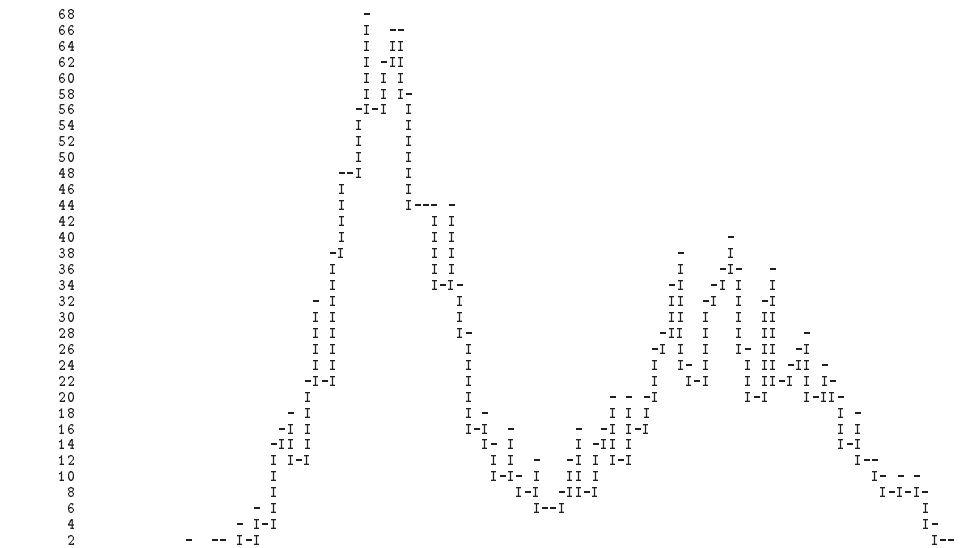

CHANNELS 100 0  
 10 0 1 2 3 4 5 6 7 8 9 0  
 1 123456789012345678901234567890123456789012345678901234567890123456789012345678901234567890

CONTENTS 10 111123234456566654443432111 1 1 11 11211112233223333222122111111  
 1. 1 11 3154368221187867616584443348583959815682574502969683732245966025146893294712079898422

LOW-EDGE 1. 11111111122222222233333333344444444555555555666666666777777777888888888999999999  
 \*10\*\* 1 0 01234567890123456789012345678901234567890123456789012345678901234567890123456789012345678901234567890123456789012345678901234567890

\* ENTRIES = 2000 \* ALL CHANNELS = 0.2000E+04 \* UNDERFLOW = 0.0000E+00 \* OVERFLOW = 0.0000E+00  
 \* BIN WID = 0.1000E-01 \* MEAN VALUE = 0.4911E+00 \* R.H.S = 0.2207E+00 \* NEQUIVAL = 0.2000E+04





HIST FILLED WITH HFILL AND HRNDH2

HBOOK ID = 210 PROJECTION X DATE 17/12/91 NO = 3

```

76           I
74           I
72           I
70           I
68           I 0 II
66           I II II
64           II II II
62           II II IO
60           OI II OII
58           II 0 IIII
56           IOII IIII I
54           IIII IIII II
52           IIII I OIII
50           IOI 0 IIII
48           I I I IOII
46           I I I IOIO
44           II I I III
42           II I I III
40           IOI I I
38           OIII I I I
36           IIII III
34           IOOI III
32           I IO OIO
30           II II IOI
28           II II III
26           II I III
24           00 I
22           I II I I I
20           I II IO II I IOII I I
18           OI III OII 0 IIII I
16           III OIII I IOI I OI I
14           IOO I OI II I IOII I
12           0 I I IO IO I I III I
10           I I I IOIOIOIOI 0
8           I OI II OIII I
6           OIO 0 I OIO
4           IO I I I I
2           00 I

```

```

CHANNELS 100 0
          10 0 1 2 3 4 5 6 7 8 9 0
          1 123456789012345678901234567890123456789012345678901234567890123456789012345678901234567890

```

```

CONTENTS 10 1112234335545656654443331111 11 1 111113122223233242322231111111 11 1
          1. 115475274447031969770012586101693260270696854072602204137731817684481677649975290445442121

```

```

LOW-EDGE 1. 111111111222222222333333333444444444555555555666666666777777777888888888999999999
*10** 1 0 012345678901234567890123456789012345678901234567890123456789012345678901234567890123456789012345678901234567890

```

```

* ENTRIES = 2000 * ALL CHANNELS = 0.2000E+04 * UNDERFLOW = 0.0000E+00 * OVERFLOW = 0.0000E+00
* BIN WID = 0.1000E-01 * MEAN VALUE = 0.4847E+00 * R . H . S = 0.2204E+00

```

HIST FILLED WITH HFILL AND HRNDH2

HBOOK ID = 210 BAND Y DATE 17/12/91 NO = 4

BAND Y NO = 1 XHIN= 0.1000E+00 XHAX= 0.5000E+00

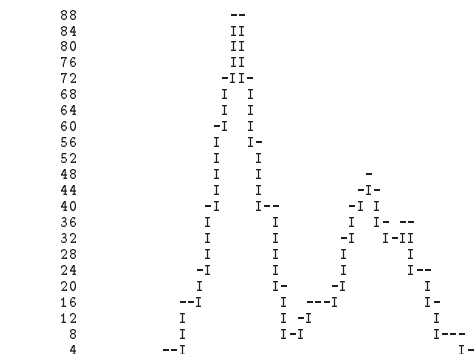

CHANNELS 10 0 1 2 3 4  
1 1234567890123456789012345678901234567890

CONTENTS 10 1123678875431 11111344443233221  
1. 3234280076140895066690028139343257552

LOW-EDGE 1. 111122223333444455556666777788889999  
\*10\*\* 1 0 025702570257025702570257025702570257  
0 05

\* ENTRIES = 1108 \* ALL CHANNELS = 0.1108E+04 \* UNDERFLOW = 0.0000E+00 \* OVERFLOW = 0.0000E+00  
\* BIN WID = 0.2500E-01 \* MEAN VALUE = 0.4800E+00 \* R. H. S. = 0.2231E+00

HIST FILLED WITH HFILL AND HRNDH2

HBOOK ID = 210 SLICE X DATE 17/12/91 NO = 5

SLICE X NO = 1 YHIN= 0.0000E+00 YHAX= 0.3333E+00



CHANNELS 100 0 1 2 3 4 5 6 7 8 9 10  
1 1234567890123456789012345678901234567890123456789012345678901234567890123456789012345678901234567890

CONTENTS 10 1 1111221221222111 11 1 1 1 11111 111 1  
1. 11226471745235063882418799235665 6634 236775603165390062286416969199797478253444112 1

LOW-EDGE 1. 1111111111222222222233333333334444444444555555555566666666667777777777888888888899999999999999  
\*10\*\* 1 0 0123456789012345678901234567890123456789012345678901234567890123456789012345678901234567890123456789

\* ENTRIES = 751 \* ALL CHANNELS = 0.7510E+03 \* UNDERFLOW = 0.0000E+00 \* OVERFLOW = 0.0000E+00  
\* BIN WID = 0.1000E-01 \* MEAN VALUE = 0.4820E+00 \* R. H. S. = 0.2188E+00

HIST FILLED WITH HFILL AND HRNDH2

HBOOK ID = 210 SLICE X DATE 17/12/91 NO = 6
SLICE X NO = 2 YHIN= 0.3333E+00 YHAX= 0.6667E+00

25 I I
24 I I I I I
23 I III I
22 I IIII I I
21 I IIIII I I
20 IO OIIII I I
19 II IIIOI O I
18 II IIIOIII III
17 II IIIIIIOOIII I
16 II IOIIIIIIII I
15 I OO II O IIIIIII III
14 I IIIII II I I III OIII
13 I IIIII OI I I IO IIIO
12 I IIIIIII I I I II
11 I OII II I I OI
10 O IOO II I II
9 I III O I I
8 II III I I III
7 II II I III
6 I I I
5 I O I IOOO IIIII III 0
4 IO I O IIIII OIIOO IO I I
3 II I I III IOOI OI I I
2 IOII I OIII III II O I
1 OOI O IO I

CHANNELS 100 0
10 0 1 2 3 4 5 6 7 8 9 0
1 12345678901234567890123456789012345678901234567890123456789012345678901234567890

CONTENTS 10 1 11111 112121111111111
1. 1124150410055936050897739471365552143344 963473821858200355998124109464568648634 23 21 1

LOW-EDGE 1. 11111111112222222233333333344444444445555555556666666777777777888888888999999999
\*10\*\* 1 0 01234567890123456789012345678901234567890123456789012345678901234567890123456789012345678901234567890

\* ENTRIES = 707 \* ALL CHANNELS = 0.7070E+03 \* UNDERFLOW = 0.0000E+00 \* OVERFLOW = 0.0000E+00
\* BIN WID = 0.1000E-01 \* MEAN VALUE = 0.4943E+00 \* R . H . S = 0.2244E+00

HIST FILLED WITH HFILL AND HRNDH2

HBOOK ID = 210 SLICE X DATE 17/12/91 NO = 7
SLICE X NO = 3 YHIN= 0.6667E+00 YHAX= 0.1000E+01

26 I
25 II I
24 II II II
23 II II II I
22 II II II I
21 OI II II I
20 IO II IO I
19 II OO OI I
18 II IIIIII
17 I IIIIIIIII I
16 I IIIIIIIIII I II
15 I IIIII III II II
14 II I O OIII II II
13 OI O I IIIO II O
12 II I I I IOI I I
11 II I I I III I
10 IO I I II I I I I I II I
9 I IO I I I I O IO III IOI I
8 I III IIIIO IIIII II I OOI I I
7 O III IOIII IOOI OI I IIIO 0 I
6 I OI IIIII I I IIIII II O IIIIII IIIIII
5 I II I I IOOO II I III I OIO I I I IIIIIIIIIIO I
4 I I III I II IOII IIIIIO O I I I I I 00 IOO00OI IIII II I
3 O I OOI I II IIIO IOOOOI I I I I 0 II OIIIIII IOII II I
2 I IIIIIIO OIIIOIIOIIIII 0 I II IIIIII IOIO IOO IO
1 O OOI O I II IO I I O I OI II OOI OI

CHANNELS 100 0
10 0 1 2 3 4 5 6 7 8 9 0
1 12345678901234567890123456789012345678901234567890123456789012345678901234567890

CONTENTS 10 11 221111121111 11 11
1. 1 3112133273069103994904423575582243213233324149575927931268388974473344444512322 1122 12

LOW-EDGE 1. 11111111112222222233333333344444444445555555556666666777777777888888888999999999
\*10\*\* 1 0 0123456789012345678901234567890123456789012345678901234567890123456789012345678901234567890

\* ENTRIES = 542 \* ALL CHANNELS = 0.5420E+03 \* UNDERFLOW = 0.0000E+00 \* OVERFLOW = 0.0000E+00
\* BIN WID = 0.1000E-01 \* MEAN VALUE = 0.4760E+00 \* R . H . S = 0.2167E+00

### 4.3 Editing operations

Histograms are output on the line printer by calling HISTD0 or HPRINT, according to the following specifications:

#### One-dimensional histograms

One histogram per page is printed, writing the global title, date, title, drawing the contour of the histogram in the range between the minimum and the maximum content, with the contents scale adjusted to fit on one page, followed by channel number, contents, and low edge of each channel, plus some statistics about the histogram itself (entries, mean value, standard deviation and so on). If the number of channels is greater than 100, the histogram is printed on several pages.

#### Two-dimensional histograms

They can use more than one page, according to the number of channels in X and Y, and in X and Y both channel number and lower edge of each channel are printed.

The plot statistics reported at the bottom consists of a table of 9 numbers, corresponding to the total contents in each of the following classes:

N1	N2	N3	N1 = underflow X , overflow Y
N4	N5	N6	N2 = X inside range , overflow Y
N7	N8	N9	N3 = overflow X , overflow Y
			N4 = underflow X , Y inside range
			N5 = X inside range , Y inside range
			N6 = overflow X , Y inside range
			N7 = underflow X , underflow Y
			N8 = X inside range , underflow Y
			N9 = overflow X , underflow Y

Any of these numbers can in fact be smaller than the real sum of the contents, in the case of saturation of a cell.

For information on how to suppress the plot statistics, see HIDOPT(ID, 'NPST')

All projections, bands and slices follow the plot they refer to as 1-dimensional histograms in the order in which they were booked.

Histograms are printed with the channels oriented along computer printer output columns, so if they extend to more than 100 channels they will be chopped into pieces of 100 channels each and printed one after the other on separate pages. The same is true for 2-dimensional histograms, the limit for tables being related to the maximum value that has to be stored in each channel (see remarks about HTABLE).

Using the entries described in this chapter, it is possible to modify the standard output format, adding or suppressing some information, choosing a different printed presentation, and modifying the mapping of histograms onto computer output pages.

One-dimensional histograms can also be printed with channels oriented along rows instead of columns, to avoid chopping up those having more than 100 channels.

All editing entries must be executed **before** calling HISTD0 or HPRINT. Some of them can be executed any time after the booking, others require that the histogram is already full, so it is good practice to group them (perhaps in one single subroutine) and execute them just before printing.

### 4.3.1 Index and General Title

It is sometimes convenient to print just the index of plots without printing all the plots themselves.

```
CALL HINDEX
```

**Action:** Prints the index.

**Remark:**

Routine HISTD0 generates the index automatically.

```
CALL HTITLE (CHGTIT)
```

**Action:** Defines a general title to be printed as the header line of each histogram.

**Input parameter:**

CHGTIT general title (character variable of up to 80 characters).

**Remark:**

- See HB00K1 about passing the title
- A call to this routine does not destroy any given individual histogram titles.

### 4.3.2 What to Print (1-dimensional histogram)

Each 1-dimensional histogram output consists of several parts, some compulsory and some optional:

general title	compulsory (if defined)
identifier, date and title	compulsory
the histogram itself	default = yes
channel numbers	default = yes
channel contents	default = yes
error values	default = no
value of the superimposed function (if any)	default = no
integrated contents	default = no
low edge of channels	default = yes
statistical information	default = yes

Routine HIDOPT can be used to change the above defaults.

```
CALL HIDOPT (ID,CHOPT)
```

**Action:** Select an option for a given histogram.

**Input parameters:**

ID Histogram identifier. If ID=0 the option is set for all histograms.

CHOPT Character variable specifying the option chosen (see table 4.1.)

Option	Action
SETD*	Set all options to the default values
SHOW	Print all the options currently set
BLAC	1 Dim histogram printed with X characters (see HPCHAR)
CONT*	1 Dim histogram is printed with the contour option
STAR	1 Dim histogram is printed with a * at the Y value (see HPCHAR)
SCAT*	Print a 2 Dim histogram as a scatter-plot
TABL	Print a 2 Dim histogram as a table
PROS*	Plot errors as the Spread of each bin in Y for profile histograms
PROE	Plot errors as the mean of each bin in Y for profile histograms
STAT	Mean value and RMS computed at filling time (double precision)
NSTA*	Mean value and RMS computed from bin contents only
ERRO	Errors bars printed as SQRT(contents)
NERR*	Do not print print error bars
INTE	Print the values of integrated contents bin by bin
NINT*	Do not print integrated contents
LOGY	1 Dim histogram is printed in Log scale in Y
LINY*	1 Dim histogram is printed in linear scale in Y
PCHA*	Print channel numbers
NPCH	Do not print channel numbers
PCON*	Print bin contents
NPCO	Do not print bin contents
PLOW*	Print values of low edge of the bins
NPLO	Do not print the low edge
PERR	Print the values of the errors for each bin
NPER*	Do not print the values of the errors
PFUN	Print the values of the associated function bin by bin
NPFU*	Do not print the values of the associated function
PHIS*	Print the histogram profile
NPHI	Do not print the histogram profile
PSTA*	Print the values of statistics (entries,mean,RMS,etc.)
NPST	Do not print values of statistics
ROTA	Print histogram rotated by 90 degrees
NROT*	Print histogram vertically
1EVL	Force an integer value for the steps in the Y axis
AEVL*	Steps for the Y axis are automatically computed
2PAG	Histogram is printed over two pages
1PAG*	Histogram is printed in one single page

A star '\*' indicates that the option is the default setting.

Table 4.1: List of available HBOOK options, which can be set by HBOOKOPT

```
CALL HSTAF (CHOPT)
```

If CHOPT= 'YES' statistics are computed at filling time. All the histograms created (via HB00K1 or HB00K2) after a CALL HSTAF ('YES'), will have the IDOPT option 'STAT' automatically activated. This is very useful when histograms are created in an indirect way like in the command NT/PLOT. The way to activate this option in paw is:

```
PAW > OPTION HSTA
PAW > NT/PLOT 10.x IDH=100
```

### 4.3.3 Graphic Choices (1-dimensional histogram)

A histogram is normally represented by drawing its contour, with a channel being represented by one character along the printed line at a displacement corresponding to the bin contents, but alternative graphic presentations are available. If some contents are negative a dotted line is drawn at Y=0.

```
CALL HPCHAR (CHOPT, CHAR)
```

**Action:** Selects a printing character different from the default for histograms that are not drawn contour only, or for superimposed functions.

#### Input parameters:

CHOPT Printing option for which the character applies. It can be:

- 'BLAC' when HIDOPT(ID, 'BLAC') is called
- 'FUNC' when HBFUN1, HFUNC or HIDOPT(ID, 'STAR') have been called.
- 'STAR' when HBFUN1, HFUNC or HIDOPT(ID, 'STAR') have been called.

CHAR Character chosen.

#### Example:

```
CALL HPCHAR ('STAR', '.')
```

Replaces the asterisk with a dot in all histograms with the HIDOPT(ID, 'STAR') option selected.

```
CALL HBIGBI (ID, NCOL)
```

**Action:** For a given 1-dimensional histogram prints one channel over a certain number of columns.

#### Input parameters:

ID Histogram identifier

NCOL Number of columns to be used per bin.  
NCOL=0 means use the full width of the page.

#### Remark:

- HBIGBI will be applied to histograms output across the page only, i.e. if  $NCHAN * NCOL \leq 100$ . If this relation is not fulfilled, then the value of NCOL will be reduced till it obeys the inequality. No restrictions if the histogram is printed down the page (HIDOPT(ID, 'ROTA')).
- If the histogram is 2-dimensional, the "bigbin" option is selected on all its projections, etc.
- It can be redefined at any time.



#### 4.3.4 Scale Definition and Normalization

Note that, whenever a multiplication by a power of ten appears in the output, it means that the quantity it refers to has been multiplied by that **factor** before being printed.

The scaling of the contents while outputting a 1-dimensional histogram is chosen by default to be linear and to span the interval between the minimum and the maximum of the contents of the channels.

The options described below allow:

- the choice of a logarithmic contents scale
- the definition of the limits of the scale
- the choice of the minimum step of the scale to be an integer
- the choice of the same scale for several histograms so that they can be compared more easily
- the normalisation of the total contents to a given value

If the identifier corresponds to a 2-dimensional histogram, they act on projections, slices, bands if any.

```
CALL HMAXIM (ID,FMAX) and CALL HMINIM (ID,FMIN)
```

**Action:** The scale limits for a histogram are not calculated automatically, but they as **set** to the specified values. The histogram contents are left intact.

##### Input parameters:

ID Histogram identifier.  
ID=0 Means apply limit to **all** existing histograms.

FMAX(FMIN) Maximum (minimum) for contents scale of given histogram.  
When  $FMAX \leq FMIN$  then the maximum and minimum values of the scale are computed automatically.

These routines can be called as often as desired for a given histogram.

```
CALL HCOMPA (IDVECT,N)
```

**Action:** Compare the contents of all histograms whose identifiers are contained in array IDVECT and assign them the same vertical scale. The comparison is made on the basis of the contents at the time routine is called.

##### Input parameters:

IDVECT Array of N elements that contain the identifiers of the histograms to be compared The array must be dimensioned in the calling program to a length larger or equal to N.

N Number of histograms to be compared  
N=0 Means compare all existing 1-dimensional histograms.

##### Remark:

This routine can be called as often as desired to recompute the histogram scales.

CALL **HNORMA** (ID,XNORM)

**Action:** Normalizes the total contents of a 1-dimensional histogram when printing it. Original contents are left intact.

**Input parameters:**

ID Histogram identifier  
 ID=0 Means apply normalization factor to **all** existing histograms

XNORM Normalization factor to be applied to histogram when printing.  
 XNORM=0 is illegal.

**Remarks:**

- If a function is superimposed, it is not affected by the normalization
- The histogram can have error bars
- The normalization factor can be redefined at any time.

CALL **HSCALE** (ID,FACTOR)

**Action:** The contents scale for a scatter plot is multiplied by a given factor.

**Input parameters:**

ID Histogram identifier  
 ID=0 Means apply scaling factor to to **all** existing 2-dimensional histograms.

FACTOR Scaling factor to be applied to the contents scale.  
 FACTOR=0 means automatic scaling. The range will be from the minimum to the maximum of the actual contents.

In a scatter-plot the contents scale starts at 0 . and increases in steps of 1. The content of each channel is represented by one character, using the following scheme:

Value	Character	Range
	.	$0 < x < 1$
1	+	$1 \leq x < 2$
2	2	$2 \leq x < 3$
3	3	$3 \leq x < 4$
⋮	⋮	⋮
9	9	$9 \leq x < 10$
10	A	$10 \leq x < 11$
11	B	$11 \leq x < 12$
12	C	$12 \leq x < 13$
⋮	⋮	⋮
overflow	*	$VMX \leq x$

**Remarks:**

- The call has no effect on the projection of histogram ID.
- The scale can be redefined several times.

**4.3.5 Page Control**

Plots are output on the line printer file, each of them starting at the beginning of a new page. The page size is an installation default. One dimensional histograms take one page, and are printed across the page. All those defaults can be overwritten as follows.

```
CALL HSQUEZ ('YES'/'NO')
```

**Action:** Suppress / reestablish page eject.

```
CALL HPAGSZ (NLINES)
```

**Action:** Changes the number of lines per page.

**Input parameter:**

NLINES Number of lines per page. The initial value of this parameter is system dependent (generally 56).

**4.3.6 Selective Editing**

Editing routines that draw histograms use a considerable amount of core, due to the complexity of the tasks they have to perform.

If the editing is performed by HISTD0 or HPRINT, all the routines that deal with 1-dimensional histograms, rotated 1-dimensional histograms, 2-dimensional histograms, get loaded even if not used (e.g. even in the case where only 1-dimensional in standard format are required).

In such cases, selective editing options for different classes can be used to replace HISTD0 or HPRINT.

```
CALL HPHIST (ID,CHOICE,NUM)
```

**Action:** Edits 1-dimensional histogram or projection, slice or band of a 2-dimensional histogram on the line printer, in the standard representation.

**Input parameters:**

ID Histogram identifier. ID=0 means edit all existing histograms.

CHOICE Character variable that selects subhistograms (irrelevant for the one-dimensional case). See routine HUNPAK for possible values.  
CHOICE=' ' is equivalent to CHOICE=' HIST'

NUM Serial order of the slice or band. NUM=0 is the same as NUM=1

Routine HPHIST ignores the option HIDOPT(ID, 'ROTA')

```
CALL HPROT (ID,CHOICE,NUM)
```

**Action:** Analogous to HPHIST, but with a presentation down the page. Parameters, special values and remarks are the same as for HPHIST.

```
CALL HPSCAT (ID)
```

**Action:** Edits a 2-dimensional histogram as a scatter-plot.

**Input parameter:**

ID Histogram identifier (2-dimensional).  
ID=0 means to edit all histograms.

**Remark:**

- The 2-dimensional histogram with identifier ID might have been booked as a table and will be output as a scatter-plot
- Projections are not printed, see HPHS.

```
CALL HPTAB (ID)
```

**Action:** Edits a 2-dimensional histogram as a table.

**Input parameter:**

ID Histogram identifier (2-dimensional).  
ID=0 means to edit all histograms.

**Remark:**

- The 2-dimensional histogram with identifier ID might have been booked as a scatterplot but it will be output as a table.

The following two routines can be used to save space when the program does not print tables and rotated 1-dimensional histograms.

```
CALL HPHS (ID)
```

**Action:** Analogous to HPRINT, but ignore tables and HIDOPT(ID, 'ROTA').

```
CALL HPHST (ID)
```

**Action:** Analogous to HPRINT, but ignore HIDOPT(ID, 'ROTA').

### 4.3.7 Printing after System Error Recovery

The operating systems of some computers define CP time limits for job execution, and abort the job with a system error when this occurs. In most of the cases, users recover from the time limit error transferring control to a summary subroutine that will eventually edit the histograms, calling, e.g. HISTD0. This can be inconvenient if the time limit condition has been reached in HISTD0 or other printing routines, because the printing will restart from the beginning. To avoid this, HBOOK can be instructed to start printing just where it stopped before.

```
CALL HPONCE
```

**Action:** In case of system error recovery during histogram editing, a possible recovery editing will start where the original printing stopped.

**Remark:**

If HPONCE has been called before printing, then a histogram that has been output completely will no longer be printed.

### 4.3.8 Changing Logical unit numbers for output and message files

The output file, containing the histograms, is by default the line printer file, where also error messages will be written.

The names of the result and error files can be redefined using:

```
CALL HOUTPU (LOUT) and CALL HERMES (LERR)
```

**Action:** Replaces the logical unit value for the results (HOUTPU) or the error messages (HERMES).

**Input parameters:**

LOUT logical unit number of the file with the printed output

LERR logical unit number of the file with error messages

<b>Example of printing options</b>
------------------------------------

```

SUBROUTINE HEXAM4
* .=====>
* .          TEST PRINTING OPTIONS
* .=====> ( R.Brun )
      DATA XMIN,XMAX/0.,1./
*
* -----
*
*          Get hist 110 from data base
*
      CALL HRGET(110,'hexam.dat',' ')
*
*          Book 2 new histograms
*
      CALL HBOOK1(1000,'TEST OF PRINTING OPTIONS',40,1.,41.,0.)
      CALL HBOOK1(2000,'TEST OF BIG BIN',20,XMIN,XMAX,0.)
      CALL HDOPT(1000,'ERRO')
*
*          Fills new IDs
*
      DO 10 I=1,40
          J=2*I-1
          W=HI(110,J)+HI(110,J+1)
          CALL HFILL(1000,FLOAT(I),0.,W)
10  CONTINUE
*
      DO 20 I=1,20
          J=5*I
          W=SQRT(HI(110,J))
          CALL HIX(2000,I,X)
          CALL HF1(2000,X,W)
20  CONTINUE
*
*          Set various printing options
*
      CALL HDOPT(110,'BLAC')
      CALL HDOPT(110,'NPLO')
      CALL HDOPT(110,'NPST')
      CALL HPHIST(110,'HIST',1)
      CALL HMAXIM(110,100.)
      CALL HDOPT(110,'1EVL')
      CALL HDOPT(110,'NPCH')
      CALL HPHIST(110,'HIST',1)
*
      CALL HDOPT(1000,'NPCH')
      CALL HDOPT(1000,'NPCO')
      CALL HPROT(1000,'HIST',1)
      CALL HDOPT(1000,'LOGY')
      CALL HPRINT(1000)
      CALL HDOPT(1000,'INTE')
      CALL HDOPT(1000,'PERR')
      CALL HDOPT(1000,'ROTA')
      CALL HPRINT(1000)
*
      CALL HBIGBI(2000,5)
      CALL HDOPT(2000,'NPCO')
      CALL HDOPT(2000,'NPLO')

```

```
CALL HPRINT(2000)
*
END
```

**Output Generated**

THIS HISTOGRAM IS FILLED ACCORDING TO THE FUNCTION HTFUN1

HBOOK ID = 110 DATE 17/12/91 NO = 8

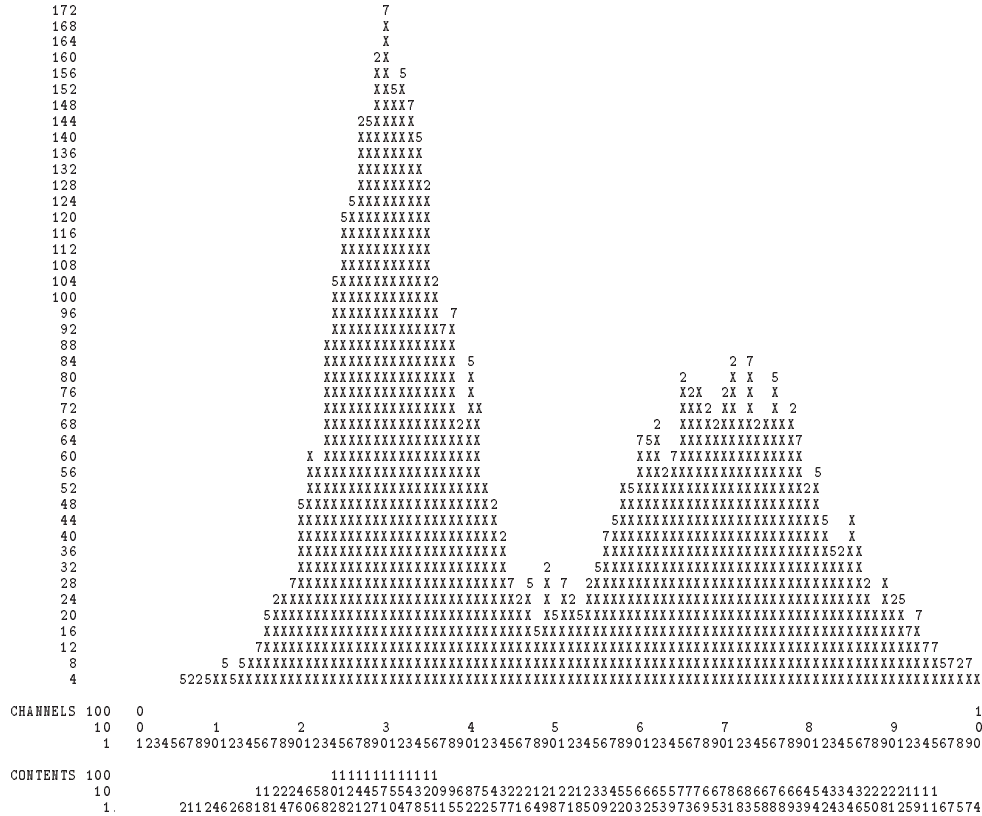

THIS HISTOGRAM IS FILLED ACCORDING TO THE FUNCTION HTFUM1

HBOOK ID = 110 DATE 17/12/91 NO = 9

```

100          XXXXXXXXXXXX
96           XXXXXXXXXXX 7
92           XXXXXXXXXXX7X
88           XXXXXXXXXXXXX
84           XXXXXXXXXXXXXXX 5
80           XXXXXXXXXXXXXXX X
76           XXXXXXXXXXXXXXX X 2 2 7
72           XXXXXXXXXXXXXXX X X2X 2X X 5
68           XXXXXXXXXXXXXXX XX XX2 2X X 2
64           XXXXXXXXXXXXXXX2X 2 XXXX2XXX
60           XXXXXXXXXXXXXXX 75X XXXXXXXXX2XXX7
56           X XXXXXXXXXXXXXXX XX 7XXXXXXXXXXXX
52           XXXXXXXXXXXXXXX XX2XXXXXXXXXXXX 5
48           XXXXXXXXXXXXXXXX X5XXXXXXXXXXXX2X
44           5XXXXXXXXXXXXXXXXXX2 XXXXXXXXXXXXXXX
40           XXXXXXXXXXXXXXXXXXXX2 5XXXXXXXXXXXXXXXX5 X
36           XXXXXXXXXXXXXXXXXXXX 7XXXXXXXXXXXXXXXXX X
32           XXXXXXXXXXXXXXXXXXXX XXXXXXXXXXXXXXX52XX
28           XXXXXXXXXXXXXXXXXXXX 2 5XXXXXXXXXXXXXXXXXXXX
24           7XXXXXXXXXXXXXXXXXXXXX7 5 X 7 2XXXXXXXXXXXXX2 X
20           2XXXXXXXXXXXXXXXXXXXXX2 X X2 XXXXXXXXXXXXXXXX25
16           5XXXXXXXXXXXXXXXXXXXXX X5X5XXXXXXXXXXXXX7
12           XXXXXXXXXXXXXXXXXXXXXXXX5XXXXXXXXXXXXXXXXXXXXX7X
8           7XXXXXXXXXXXXXXXXXXXXX XXXXXXXXXXXXXXXXXXXXXXXX77
4           5 5XXXXXXXXXXXXXXXXXXXXX XXXXXXXXXXXXXXXXXXXXXXXX5727
           5225XX5XXXXXXXXXXXXXXXXXXXXX XXXXXXXXXXXXXXXXXXXXXXXX

```

CONTENTS 100 11111111111111

10 1122465801244575543209968754322212121212334556665577766786866766645433432222111

1. 21124626818147606828212710478511552225771649871850922032539736953183588893942434650812591167574

TEST OF PRINTING OPTIONS

HBOOK ID = 1000 DATE 17/12/91 NO = 10

```

100          1 1 1 1 1 1 2 2 2 2 2 2 3 3 3
10           1 3 4 6 8 9 1 2 4 6 7 9 0 2 4 5 7 8 0 2 3
1.           6 2 8 4 0 6 2 8 4 0 6 2 8 4 0 6 2 8 4 0 6

```

LOW EDGE I---I---I---I---I---I---I---I---I---I---I---I---I---I---I---I---I---I---

```

2
3
4
5 IOI
6 OI
7 IOI
8 IO-I
9 IO-I
10 I-O-I
11 I-O-I
12 I---0--I
13 I---0---I
14 I---0---I
15 I---0---I
16 I---0---I
17 I---0---I
18
19 I---0---I
20 I---0---I
21 I---0---I
22 I-O-I
23 IO-I
24 IO-I
25 IO-I
26 IO-I
27 IO-I
28 I-O-I
29 I-O-I
30 I-O-I
31 I---0--I
32 I-O--I
33 I---0--I
34 I---0--I
35 I---0--I
36 I---0--I
37 I---0---I
38 I---0---I
39 I---0--I
40 I-O-I

```

LOW EDGE I---I---I---I---I---I---I---I---I---I---I---I---I---I---I---I---I---I---

```

100          1 1 1 1 1 1 2 2 2 2 2 2 3 3 3
10           1 3 4 6 8 9 1 2 4 6 7 9 0 2 4 5 7 8 0 2 3
1.           6 2 8 4 0 6 2 8 4 0 6 2 8 4 0 6 2 8 4 0 6

```

\* ENTRIES = 40 \* ALL CHANNELS = 0.4556E+04 \* UNDERFLOW = 0.0000E+00 \* OVERFLOW = 0.0000E+00

\* BIN WID = 0.1000E+01 \* MEAN VALUE = 0.2331E+02 \* R . H . S = 0.9558E+01



TEST OF PRINTING OPTIONS

HBOOK ID = 1000

DATE 17/12/91

NO = 11

```

354 814          OI
316 228          OI00
281 838          II I
251 189          O  O
223 872          I  II
199 526          O  O
177 828          I  II
158 489          I  O
141 254          I  II
125 833          O  O
112 202          I  OII
100             I  O
89 125          I  O
79 433          O  I
70 795          I  O
63 096          I  I
56 234          I  I II
50 119          O  OI00I
44 668          I  IOIIO
39 811          I  I I
35 481          I  I
31 623          O  I
28 184          I  I
25 119          I  I
22 387          I
19 953
17 783          I
15 849          I
14 125          O
12 589          I
11 22           II
10             I
8 913          IO
7 943          II
7 079          II
6 31          OI
5 623          II
5 012          I
4 467          I
3 981          I
3 548          II
3 162          II
2 818          II
2 512          II
2 239          00
    
```

LOW-EDGE 10 1111111111222222222233333333334  
 1. 1234567890123456789012345678901234567890

\* ENTRIES = 40 \* ALL CHANNELS = 0.4556E+04 \* UNDERFLOW = 0.0000E+00 \* OVERFLOW = 0.0000E+00  
 \* BIN WID = 0.1000E+01 \* MEAN VALUE = 0.2331E+02 \* R . H . S = 0.9558E+01

TEST OF PRINTING OPTIONS

```

HBOOK      ID =      1000                      DATE 17/12/91                      NO = 12

100
10
1  2  2  3  3  5  6  7  1  1  1  1  2  3  3  5  6  7  1  1  1  1  2  3
0  0  5  1  9  0  3  9  0  2  5  9  5  1  9  0  3  9  0  5  8  9  1  6
0  0  1  6  8  1  1  4  0  9  5  5  2  2  1  2  0  3  0  9  9  3  9  3

LOW EDGE  INTEGRAT  ERRORS  I---I---I---I---I---I---I---I---I---I---I---I---I---I---I---I---
2
3
4      2      1.414  0-----I
5      4      1.414  0-----I
6      10     2.449      I-----0-----I
7      18     2.828      I-----0-----I
8      32     3.742      I-----0-----I
9      61     5.385      I-----0-----I
10     106    6.708      I---0---I
11     179    8.544      I--0-I
12     295   10.777      I-0-I
13     485   13.784      I-0-I
14     725   15.492      I-OI
15     1008  16.823      IOI
16     1336  18.111      IOI
17     1640  17.436      IOI
18     1925  16.882      IOI
19     2151  15.033      I-OI
20     2337  13.638      IO-I
21     2484  12.124      IO-I
22     2608  11.136      IO-I
23     2690  9.055      I-0-I
24     2738  6.928      I--0-I
25     2778  6.325      I--0-I
26     2825  6.856      I-0-I
27     2873  6.928      I--0-I
28     2916  6.557      I-0-I
29     2985  6.307      IO-I
30     3079  6.695      IO-I
31     3192  10.63      I-OI
32     3319  11.269      I-OI
33     3431  10.583      IO-I
34     3581  12.247      I-OI
35     3726  12.042      I-OI
36     3864  11.747      IO-I
37     4013  12.207      IO-I
38     4161  12.166      IO-I
39     4307  12.083      IOI
40     4444  11.705      IOI
41     4556  10.583      IO-I

LOW EDGE  INTEGRAT  ERRORS  I---I---I---I---I---I---I---I---I---I---I---I---I---I---I---I---
100
10
1  2  2  3  3  5  6  7  1  1  1  1  2  3  3  5  6  7  1  1  1  1  2  3
0  0  5  1  9  0  3  9  0  2  5  9  5  1  9  0  3  9  0  5  8  9  1  6
0  0  1  6  8  1  1  4  0  9  5  5  2  2  1  2  0  3  0  9  9  3  9  3

* ENTRIES = 40      * ALL CHANNELS = 0.4556E+04      * UNDERFLOW = 0.0000E+00      * OVERFLOW = 0.0000E+00
* BIN WID = 0.1000E+01  * MEAN VALUE = 0.2331E+02      * R . H . S = 0.9558E+01

```

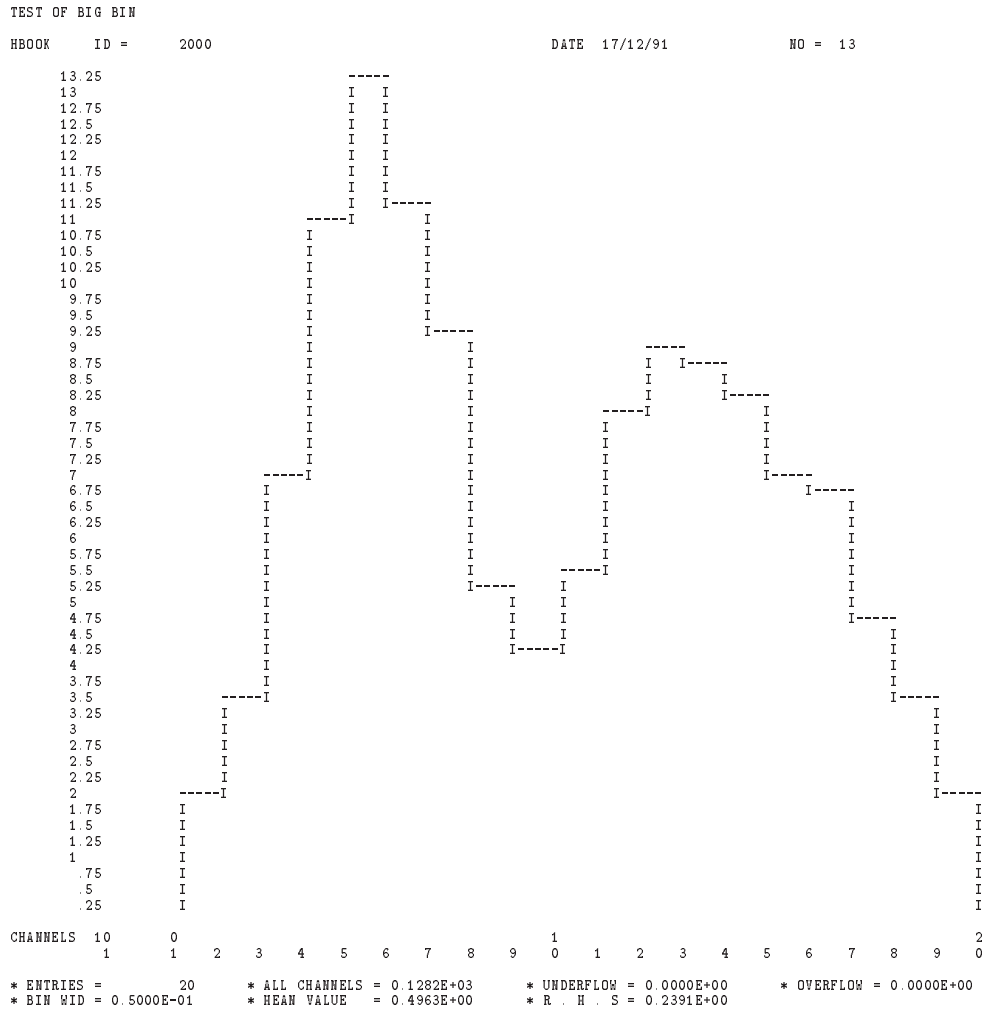

## Chapter 5: Accessing Information

The information contained in a histogram can be made available in local Fortran variables with the commands described below. It is possible to access channel contents (all together or individually) and also mean value and standard deviation of 1-dimensional distributions.

### 5.1 Testing if a histogram exists in memory

```
LOGVAR = HEXIST (ID)
```

**Action:** Returns a logical value of `.TRUE.` if and histogram exists and `.FALSE.` otherwise.

**Input parameter:**

ID Histogram identifier

**Remark:**

HEXIST has to be declared LOGICAL in the calling routine.

### 5.2 List of histograms

```
CALL HID1 (IDVECT*,N*)
```

**Action:** Returns the number and identifiers of all existing 1-dimensional histograms.

**Output Parameters:**

IDVECT Array which will contain the histogram identifiers, in booking order. Its dimension should be at least equal to the number of 1-dimensional histograms.

N Number of 1-dimensional histograms.

```
CALL HID2 (IDVECT*,N*)
```

**Action:** Returns the number and identifiers of all existing 2-dimensional histograms. (see HID1).

```
CALL HIDALL (IDVECT*,N*)
```

**Action:** Returns the number and identifiers of **all** existing histograms. (see HID1).

### 5.3 Number of entries

```
CALL HNOENT (ID,NOENT*)
```

**Action:** Provides the number of entries of a **memory resident** histogram, plot or Ntuple. **N.B. The value returned includes also the contents of the overflow and underflow bins.**

**Input parameter:**

ID Histogram identifier

**Output Parameter:**

NOENT Number of entries in the given histogram.

## 5.4 Histogram attributes Contents

```
CALL HKIND (ID,KIND*,CHOPT)
```

**Action:** Returns the attributes of a histogram

### Input parameters:

ID Histogram identifier

CHOPT Character variable specifying desired option.

' ' (default) only KIND(1) is filled, according to the following convention:

- 1 unknown kind of histogram;
- 0 identifier ID does not exist;
- 1 one-dimensional plot;
- 2 two-dimensional plot;
- 3 table;
- 4 Ntuple;
- 8 profile histogram.

'A' More complete information on histogram; all "status bits" characterizing the histogram are expanded into the vector KIND(32), using the following conventions:

KIND( 1)	HBOOK1	KIND(17)	HBIGBI
KIND( 2)	HBOOK2	KIND(18)	HNORMA
KIND( 3)	HTABLE	KIND(19)	HSCALE
KIND( 4)	NTUPLE	KIND(20)	HMAXIM
KIND( 5)	Automatic binning	KIND(21)	HMINIM
KIND( 6)	Variable bin sizes	KIND(22)	HINTEG
KIND( 7)	HBSTAT	KIND(23)	H2PAGE
KIND( 8)	Profile histogram	KIND(24)	H1EVLI
KIND( 9)	HBARX	KIND(25)	HPRSTA
KIND(10)	HBARY	KIND(26)	HLOGAR
KIND(11)	HERROR	KIND(27)	HBLACK
KIND(12)	HFUNC	KIND(28)	HSTAR
KIND(13)	HROTAT	KIND(29)	HPRCHA
KIND(14)	HPRFUN	KIND(30)	HPRCON
KIND(15)	HPRLOW	KIND(31)	HPRERR
KIND(16)	HPRHIS		

### Output parameter:

KIND Integer array (of dimension 32) which will contain the information returned about histogram ID. See above for a detailed explanation of its contents.

## 5.5 Contents

```
CALL HUNPAK (ID,CONTEN*,CHOICE,NUM)
```

**Action:** Transfer the contents of a histogram or a selected projection of a 2-dimensional histogram into a local array.

### Input parameters:

ID Histogram identifier

CHOICE Character variable selecting subhistograms (irrelevant for the 1-dimensional case)

'HIST' the 2-dimensional histogram itself. Default CHOICE=' ' is equivalent to 'HIST'.

'PROX' X projection

'PROY' Y projection

'SLIX' X slice

'SLIY' Y slice

'BANX' X band

'BANY' Y band

NUM Serial order of the slice or band that is requested. If NUM=0, it is assumed to be 1.

### Output Parameter:

CONTEN Array to be dimensioned at least to the number of channels of the histogram (or projection), i.e. DIMENSION CONTEN(NX) in the 1-dimensional case and DIMENSION CONTEN(NX,NY) in the 2-dimensional case.

```
VARIAB = HI (ID,I) and VARIAB = HIJ (ID,I,J)
```

**Action:** These functions return the channel contents in a given histogram bin in the 1-dimensional and 2-dimensional case respectively.

### Input parameters:

ID Histogram identifier.

I Bin number for X-coordinate. For I=0 HI returns the number of underflows in X.

J (HIJ only) Bin number for Y-coordinate. For J=0 HIJ returns the number of underflows in Y.

When NX, NY are respectively the number of channels in X and Y and I=NX+1, J=NY+1, then HI/HIJ returns the number of overflows

```
VARIAB = HX (ID,X) and VARIAB = HXY (ID,X,Y)
```

**Action:** These functions return the channel contents in a given histogram of the bin which contains a given value in X (1-dimensional case) or a given pair of (X,Y) (2-dimensional case).

### Input parameters:

ID Histogram identifier

X X-value

Y Y-value (2-dimensional case, i.e. HXY only)

## 5.6 Errors

```
CALL HUNPKE (ID,CONTEN*,CHOICE,NUM)
```

**Action:** Transfer the error contents of a histogram or a selected projection of a 2-dimensional histogram into the local array.

### Input parameters:

ID Histogram identifier

CHOICE Character variable selecting subhistograms (irrelevant for the 1-dimensional case)

'HIST' the 2-dimensional histogram itself

'PROX' X projection

'PROY' Y projection

'SLIX' X slice

'SLIY' Y slice

'BANX' X band

'BANY' Y band

CHOICE=' ' is equivalent to 'HIST'.

NUM Serial order of the slice or band that is requested.  
If NUM=0, it is assumed to be 1.

### Output Parameter:

CONTEN Array to be dimensioned at least to the number of channels of the histogram (or projection), i.e. DIMENSION CONTEN(NX) in the 1-dimensional case and DIMENSION CONTEN(NX,NY) in the 2-dimensional case.

```
VARIAB = HIE (ID,I)
```

**Action:** Returns the value of the error that has been stored in a given 1-dimensional histogram channel. This corresponds to the square root of the sum of the squares of the weights.

### Input parameters:

ID Histogram identifier.

I Channel (bin) number.

When HBARX has not been called HIE returns the square root of the contents of the given channel.

```
VARIAB = HXE (ID,X)
```

**Action:** Analogous to HIE but referring to the channel that contains a given X-value.

### Input parameters:

ID Histogram identifier.

X X-value.

The same remark as for HIE applies.

## 5.7 Associated function

```
VARIAB = HIF (ID,I)
```

**Action:** Function returning the value of the associated function that has been stored in a given histogram channel. The function value will be zero if no associated function exists.

### Input parameters:

ID Histogram identifier.  
I Channel (bin) number.

## 5.8 Abscissa to channel number

```
CALL HXI (ID,X,I*) and CALL HXYIJ (ID,X,Y,I*,J*)
```

**Action:** Return the number of the channel (cell) which contains a given value in X (1-dimensional case) or a given pair of (X, Y) (2-dimensional case).

### Input parameters:

ID Histogram identifier  
X X-value  
Y Y-value (2-dimensional case, i.e. HXYIJ only)

### Output Parameters:

I Channel number in X-dimension.  
Under/Overflows give I=0 or I=NCHANX+1 respectively.  
J Channel number in Y-dimension (2-dimensional case, i.e. HXYIJ only).  
Under/Overflows give J=0 or J=NCHANY+1 respectively.

```
CALL HIX (ID,I,X*) and CALL HIJXY (ID,I,J,X*,Y*)
```

**Action:** Returns the X-coordinate of the lower edge of a given channel (1-dimensional case) or the X-Y coordinate pair if a given cell (2-dimensional case).

### Input parameters:

ID Histogram identifier.  
I Channel or cell number in X-dimension, with  $1 \leq I \leq NCHANX$ .  
J Cell number in Y-dimension with  $1 \leq J \leq NCHANY$ . (2-dimensional case, i.e. HIJXY only)

### Output Parameters:

X X-coordinate of lower edge of channel or cell.  
Y Y-coordinate of lower edge of cell. (2-dimensional case, i.e. HIJXY only).



## 5.9 Maximum and Minimum

```
VARIAB = HMAX (ID) and VARIAB = HMIN (ID)
```

**Action:** Returns the maximum or minimum channel contents of a histogram (without underflow and overflow). In the case of a 2-dimensional histogram the returned value does not take into account projections.

### Input parameter:

ID Histogram identifier.

## 5.10 Rebinning

```
CALL HREBIN (ID,X*,Y*,EX*,EY*,N,IFIRST,ILAST)
```

**Action:** The specified channels of a 1-dimensional histogram are cumulated (rebinned) into new bins. The final contents of the new bin is the *average* of the original bins.

### Input parameters:

ID Histogram identifier

N Number of elements in the output arrays X, Y, EX, EY.

IFIRST First histogram channel on which the rebinning has to be performed.

ILAST Last histogram channel on which the rebinning has to be performed.

### Output Parameters:

X Array containing the new abscissa values.

Y Array containing the cumulated contents.

EX Array containing the X errors.

EY Array containing the Y errors.

The abscissa errors on the rebinned histogram are calculated to be half the bin width.

If the standard deviation on the abscissa values is instead required, then specify N as a negative number. In this case, the returned abscissa error for each bin is the bin width divided by the square root of 12.

This routine may also be used for histograms with unequal bin widths.

### Example:

```
CALL HREBIN (ID,X,Y,EX,EY,25,11,85)
```

This call will regroup channels 11 to 85 three by three (25 bins) and return new abscissa, contents and error values in the output arrays. In this case the errors in X will be equal to  $1.5 \cdot \text{BINWIDTH}$ .

```
CALL HREBIN (ID,X,Y,EX,EY,NCHAN,1,NCHAN)
```

This example shows a convenient way (using one subroutine call) to return the abscissa, contents and errors for a 1-dimensional histogram. Note that in this case the errors in X are equal to  $0.5 \cdot \text{BINWIDTH}$ .

## 5.11 Integrated contents

```
VARIAB = HSUM (ID)
```

**Action:** Returns the integrated contents of a histogram (without underflow and overflow). In the case of a 2-dimensional histogram the returned value does not take into account projections.

**Input parameter:**

ID Histogram identifier.

## 5.12 Histogram definition

```
CALL HGIVE (ID, CHTITL*, NX*, XMI*, XMA*, NY*, YMI*, YMA*, NWT*, LOC*)
```

**Action:** Returns the booking parameters and address of a given histogram.

**Input parameter:**

ID Histogram identifier, cannot be zero.

**Output Parameters:**

CHTITL Histogram title (must be declared CHARACTER\*80)  
 NX Number of channels in X  
 XMI Lower edge of first X channel  
 XMA Upper edge of last X channel  
 NY Number of channels in Y (zero for a 1-dimensional histogram)  
 YMI Lower edge of first Y channel  
 YMA Upper edge of last Y channel  
 NWT Number of machine words for the title. If there is no title, NWT is returned as 0 .  
 LOC Address of the histogram in the common /PAWC/.

```
CALL HDUMP (ID)
```

**Action:** Prints a dump of the HB00K storage area corresponding to a given histogram.

**Input parameter:**

ID Histogram identifier.  
 ID=0 will dump the whole of the HB00K central memory storage area.

### 5.13 Statistics

```
VARIAB = HSTATI (ID, ICASE, CHOICE, NUM)
```

**Action:** This function of type REAL returns the mean value, standard deviation or number of equivalent events of a 1-dimensional distribution. Underflows and overflows are not included in the calculation.

**Input parameters:**

ID	Histogram identifier
ICASE	1 Mean value 2 Standard deviation 3 Number of equivalent events
CHOICE	See HUNPAK
NUM	See HUNPAK

If HIDEOPT(ID, 'STAT') has been called, the results are based on the information stored at filling time. Otherwise the results are based on the channel contents only. If  $x_i$  and  $w_i$  represent the value and contents of event  $i$ , then one has the following relations:

$$\begin{aligned} \text{Expectation value } E(x) &= \frac{\sum_{i=1}^n w_i x_i}{\sum_{i=1}^n w_i} \\ \text{Mean value} &= E(x) \\ \text{Central moment of order } n, M(n) &= E((x - E(x))^n) \\ \text{Standard deviation} &= \sqrt{M(2)} \\ \text{Number of equivalent events} &= \frac{(\sum_{i=1}^n w_i)^2}{\sum_{i=1}^n w_i^2} \end{aligned}$$

## Chapter 6: Operations on Histograms

### 6.1 Arithmetic Operations

Histograms can be added, subtracted, divided or multiplied, provided their number of channels are the same.

```
CALL HOPERA (ID1,CHOPER,ID2,ID3,C1,C2)
```

**Action:** Fills an histogram I3 with values such that, logically (operands are the bin contents)

$$ID3 = C1 * ID1 \text{ (OPERATION) } C2 * ID2$$

#### Input parameters:

ID1, ID2 Operand histogram identifiers.

CHOPER Character variable specifying the kind of operation to be performed (+, -, \*, /);  
'B' compute binomial errors;  
'E' compute error bars on the resulting histograms correctly, assuming that the input histograms ID1 and ID2 are independent.  
For instance /BE will generate binomial errors for the division of ID1 by ID2.

ID3 Identifier of the histogram containing the result after the operation.

C1, C2 Multiplicative constants.

#### Remark:

- ID1, ID2 and ID3 must have the same number of channels.
- If histogram ID3 is not empty, its contents are overwritten
- The output histogram ID3 can be either one of the input histograms ID1 or ID2.
- If histogram ID3 does not exist, it is created by HOPERA with the same specification as for histogram ID1.
- The mean value, standard deviation, etc. are calculated from the contents of the resulting histogram ID3, unless the 'STAT' option is active and the operation is an addition or subtraction, in which case they are computed exactly.
- A division by zero gives zero.
- Negative results for bin contents in a packed histogram are meaningless
- The number of entries in the resulting histogram ID3 is set to the sum of the entries in histograms ID1 and ID2.
- When an operation is performed on two 1-dimensional histograms with the sum of the squares of the weights stored (option HBARX), the error on the resulting histogram is calculated supposing that the contents of the two input histograms ID1 and ID2 are uncorrelated. This is valid also for projections, slices and bands of 2-dimensional histograms.
- If histogram ID3 is packed the number of bits allocated per channel (cell) has to be sufficient to store the results.

## 6.2 Statistical differences between histograms

```
CALL HDIFF (ID1, ID2, PROB*, CHOPT)
```

**Action:** Statistical test of compatibility in shape between two histograms using the Kolmogorov test. The histograms are compared and the probability that they could come from the same parent distribution is calculated.

The comparison may be done between two 1-dimensional histograms or between two 2-dimensional histograms. For further details on the method, see 6.2.2 below.

### Input parameters:

- ID1 Identifier of first histogram to be compared.
- ID2 Identifier of second histogram to be compared.
- CHOPT A character string specifying the options desired.
- 'D' Debug printout, produces a blank line and two lines of information at each call, including the identifier numbers ID, the number of events in each histogram, the value of PROB, and the maximum Kolmogorov distance between the two histograms. For 2-dimensional histograms, there are two Kolmogorov distances (see below). If option 'N' is specified, there is a third line of output giving the probability PROB for shape and normalization alone separately.
  - 'F1' Histogram ID1 has no errors (it is a function).
  - 'F2' Histogram ID2 has no errors (it is a function).
  - 'N' Include a comparison of the relative normalization of the two histograms, in addition to comparing the shapes. The output parameter PROB is then a combined confidence level taking into account absolute contents.
  - 'O' Overflow, requests that overflow bins be taken into account (also valid for 2-dim).
  - 'U' Underflow, requests that underflow bins be taken into account (also valid for 2-dim).

### For 2-dimensional histograms only

- 'L' Left, include X-underflows in the calculation.
- 'R' Right, include X-overflows in the calculation.
- 'B' Bottom, include Y-underflows in the calculation.
- 'T' Top, include Y-overflows in the calculation.

### Output Parameter:

- PROB The probability of compatibility between the two histograms.

### Remark:

- Options 'O' and 'U' can also refer to 2-dimensional histograms, so that, for example the string 'UT' means that underflows in X and Y and overflows in Y should be included in the calculation.
- The histograms ID1 and ID2 must exist and already have been filled before the call to HDIFF. They must also have identical binning (lower and upper limits as well as number of bins).

- The probability `PROB` is returned as a number between zero and one. A values close to one indicates very similar histograms, and a value near zero means that it is very unlikely that the two arose from the same parent distribution.
- By default (no options selected with `CHOPT`) the comparison is done only on the shape of the two histograms, without consideration of the difference in number of events, and ignoring all underflow and overflow bins.

### 6.2.1 Weights and Saturation

#### Weighted 1-dimensional histograms

It is possible to compare weighted with weighted histograms, and weighted with unweighted histograms, but only if `HBOOK` has been instructed to maintain the necessary information by appropriate calls (before filling) to `HBARX`. However it is not possible to take into account underflow or overflow bins if the events are weighted.

#### Saturated 1-dimensional histograms

If there is saturation (more than the maximum allowed contents in one or more bins), the probability `PROB` is calculated as if the bin contents were exactly at their maximum value, ignoring the saturation. This usually will result in a higher value of `PROB` than would be the case if the memory allowed the full contents to be stored, but not always. It should therefore be realized that the results of `HDIFF` are not accurate when there is saturation, and it is the user's responsibility to avoid this condition.

#### 2-dimensional histograms

Routine `HDIFF` cannot work if the events are weighted, since, in the current version of `HBOOK`, the necessary information is not maintained. `HDIFF` will also refuse to compare 2-dimensional histograms if there is saturation, since it does not have enough information in this case.

### 6.2.2 Statistical Considerations

#### The Kolmogorov Test

The calculations in routine `HDIFF` are based on the Kolmogorov Test (See, e.g. [11], pages 269-270). It is usually superior to the better-known Chisquare Test for the following reasons:

- It does not require a minimum number of events per bin, and in fact it is intended for unbinned data (this is discussed below).
- It takes account not only of the differences between corresponding bins, but also the sign of the difference, and in particular it is sensitive to a sequence of consecutive deviations of the same sign.

In discussing the Kolmogorov test, we must distinguish between the two most important properties of any test: its **power** and the calculation of its **confidence level**.

### The Power

The job of a statistical test is to distinguish between a null hypothesis (in this case: that the two histograms are compatible) and the alternative hypothesis (in this case: that the two are not compatible). The power of a test is defined as the probability of rejecting the null hypothesis when the alternative is true. In our case, the alternative is not well-defined (it is simply the ensemble of all hypotheses except the null) so it is not possible to tell whether one test is more powerful than another in general, but only with respect to certain particular deviations from the null hypothesis. Based on considerations such as those given above, as well as considerable computational experience, it is generally believed that tests like the Kolmogorov or Smirnov-Cramer-Von-Mises (which is similar but more complicated to calculate) are probably the most powerful for the kinds of phenomena generally of interest to high-energy physicists. This is especially true for two-dimensional data where the Chisquare Test is of little practical use since it requires either enormous amounts of data or very big bins.

### The Confidence Level for 1-dimensional data

Using the terms introduced above, the confidence level is just the probability of rejecting the null hypothesis when it is in fact true. That is, if you accept the two histograms as compatible whenever the value of `PROB` is greater than 0.05, then truly compatible histograms should fail the test exactly 5% of the time. The value of `PROB` returned by `HDIFF` is calculated such that it will be uniformly distributed between *zero* and *one* for compatible histograms, provided the data are not binned (or the number of bins is very large compared with the number of events). Users who have access to unbinned data and wish exact confidence levels should therefore not put their data into histograms, but should save them in ordinary Fortran arrays and call the routine `TKOLM0` which is being introduced into the Program Library. On the other hand, since `HBOOK` is a convenient way of collecting data and saving space, the routine `HDIFF` has been provided, and we believe it is the best test for comparison even on binned data. However, the values of `PROB` for binned data will be shifted slightly higher than expected, depending on the effects of the binning. For example, when comparing two uniform distributions of 500 events in 100 bins, the values of `PROB`, instead of being exactly uniformly distributed between *zero* and *one*, have a mean value of about 0.56. Since we are physicists, we can apply a useful rule: As long as the bin width is small compared with any significant physical effect (for example the experimental resolution) then the binning cannot have an important effect. Therefore, we believe that for all practical purposes, the probability value `PROB` is calculated correctly provided the user is aware that:

- The value of `PROB` should not be expected to have **exactly** the correct distribution for binned data.
- The user is responsible for seeing to it that the bin widths are small compared with any physical phenomena of interest.
- The effect of binning (if any) is always to make the value of `PROB` slightly too big. That is, setting an acceptance criterion of (`PROB`>0.05 will assure that **at most** 5% of truly compatible histograms are rejected, and usually somewhat less.

### The Confidence Level for Two-dimensional Data

The Kolmogorov Test for 2-dimensional data is not as well understood as for one dimension. The basic problem is that it requires the unbinned data to be ordered, which is easy in one dimension, but is not well-defined (i.e. not scale-invariant) in higher dimensions. Paradoxically, the binning which was a nuisance in one dimension is now very useful, since it enables us to define an obvious ordering. In fact there are

two obvious orderings (horizontal and vertical) which give rise to two (in general different) Kolmogorov distance measures. Routine HDIFF takes the average of the two distances to calculate the probability value PROB, which gives very satisfactory results. The precautions necessary for 1-dimensional data also apply to this case.

### 6.3 Bin by bin histogram comparisons

```
CALL HDIFFB (ID1, ID2, TOL, NBINS, CHOPT, NBAD*, DIFFS*)
```

**Action:** Compare two histograms, bin by bin. For each bin, return the probability that the contents are from the same distribution. For details of the method see below.

The comparison may be done between two 1-dimensional histograms, two 2-dimensional histograms, or between two profile histograms.

#### Input parameters:

- ID1     The first histogram to be compared. The “reference” histogram in options A and C.
- ID2     The second histogram to be compared. The “data” histogram in options A and C.  
ID1, ID2 are a pair of 1-D, 2-D, or profile histograms booked with the same number of bins.
- TOL     The tolerance for a passing the test. Under options S and C, TOL is a number between 0 and 1 which represents the smallest probability considered as an acceptable match. TOL=0.05 will cause DIFFS to reject the bin as bad if there is less than a 5% probability the two bins came from the same distribution. Under option A, TOL is the degree of precision of match required for the test to be considered as passed. TOL=2.0 means that a data bin differing from the reference mean by less than 2.0 times the reference error is compatible.
- NBINS   The number of bins in the comparison. For a 1-dimensional histogram, this is the number of bins plus 0, 1 or 2, depending on whether the overflow and underflow channels are included. For a 2-dimensional histogram, this will have the total number of bins plus room for overflow bins along any of the axes requested. For more detail, see the discussion of DIFFS below.
- CHOPT   A string allowing specification of the following options:
- N   Use the absolute contents of each histogram, thus including the normalization of the histogram as well as its shape in the comparison. By default, for the S and C options, in 1- and 2-dimensional histograms, the means are adjusted for the relative numbers of entries (including any overflow or underflow bins requested) in ID1 and ID2. No adjustment is ever made for profile histograms.
  - 0   Overflow, requests that overflow bins be taken into account.
  - U   Underflow, requests that underflow bins be taken into account.
  - R   Right overflow bin. For a 2-dimensional histogram, it includes the X-Axis overflow bin in the comparisons. If the 0 option is used, this is automatic.
  - L   Left underflow bin. Same as above, but the X-Axis underflow is used. The U option uses this automatically.
  - T   Top overflow bin. Same as R, but for the Y-Axis.
  - B   Bottom underflow bin. Option L for the Y-Axis.



- S Statistical comparison. Calculates the probability that both bins were produced from a distribution with the same mean. This probability is referred to in TOL and DIFFS.
- C Compatibility test. Considers bins of the reference histogram (ID1) as perfectly describing the true distribution. Calculates the probability that the data (from ID2) was produced from that distribution. For 1- or 2-dimensional histograms, the Poisson mean is deduced from ID1. For profile histograms, the test assumes a Gaussian with mean and standard deviation given by the ID1. The C option should be used when comparing data to a function, a well-known reference, or a calibration distribution.
- A Absolute test. Like the C test, except that TOL and DIFFS are in terms of the number of standard deviations, rather probability. The test is on the number of standard deviations by which the data from ID2 deviates from the mean. Both the mean and the standard deviation are deduced from ID1. Error bars must be on for this option. This forbids overflow bins, underflow bins, and 2-dimensional histograms. The A option ignores bins with zero contents in reference histogram.
- Z Ignores bins with zero contents in the comparison. For the S option, ignores bins with zero contents in either histogram. For the C and A option, ignores bins with zero contents in the reference histogram. The default action is to consider all bins as significant.
- D Debug printout, dumps the critical variables in the comparisons, along with indicators of its weight, etc. The default (no options selected) does the S option (statistical comparison), ignores underflow and overflow bins, and automatically corrects for the difference in entries between ID1 and ID2.

#### Output parameters:

- NBAD\* The number of bins failing the compatibility test according to the criteria defined by TOL and CHOPT.
- DIFFS\* An array of length the number of bins being compared, which gives the results of the test bin by bin (confidence levels for options S and C, deviations for option A). Results are passed back in the form:
- 1-D DIFFS(NX) for no over or underflow or DIFFS(0:NX+1), for overflow and/or underflow.
  - 2-D DIFFS(NX, NY) or DIFFS(0:NX+1, 0:NY+1).

#### When to use HDIFFB instead of HDIFF:

HDIFFB treats the histogram bins individually, while HDIFF treats the histogram as a whole. In HDIFF, one is comparing the overall shapes of a probability distribution. Typically, an event is entered only in one channel, and the choice of channel depends on a measured value of a continuous coordinate, so that it makes sense for downward fluctuations in one bin to be considered as compensated by upward fluctuations in another bin. In HDIFFB, each bin is considered independently, except, perhaps, for an overall normalization factor which is the sum over all bins.

Thus HDIFFB is appropriate when:

- It makes sense to identify a single channel as “bad”, for example if the bin contents correspond to hits in a given detector element.
- The data is heterogeneous, for example if the contents are counts versus trigger bit.
- You have already found a discrepancy on a shape with HDIFF and wish to focus on where disagreement is worst.

A plot of hits versus detector element, where the detector elements cover some angular range, is an example of a histogram which might be considered with either comparison utility. The choice depends on the question you wish to answer:

- If you want to know if the angular distribution looks the same, use HDIFF.
- If you want a report on bad detector elements, use HDIFFB.

### 6.3.1 Choice of TOL:

If you choose 0.05 for TOL, you should expect 5 or so bad bins per trial from a histogram with 100 channels. For monitoring, you must compromise between the number of false messages you can tolerate (based on the total number of channels you monitor), and the amount of data you will need to collect to claim a channel is bad. In general, a somewhat smaller fraction of channels than TOL will be flagged as bad, since for discrete distributions (Poisson statistics), the probability is quantized. For example, the probability might be 0.053 for 4 entries, and 0.021 for 3. If TOL=0.05, only bins with 3 or fewer entries would be flagged as bad.

#### When to use the S option:

The S option should be used when both histograms are filled with statistical data, for example a momentum distribution from two successive data runs. Using the S option when comparing data to a function or known reference yields poor results because it attributes errors to both histograms. In this case, the C option should be selected.

#### When to use the C option:

The C option assumes that the reference histogram contains the theoretically expected values with no (or negligible) errors. Examples might be a flat distribution hand-inserted as the expectation for a phi distribution, or a long data run to be compared with shorter data runs.

#### When to use the A option:

The A option can be used as an equivalent to the C option by choosing TOL in terms of standard deviations instead of probability, and returns  $z$  values in DIFFS for each bin.

The A option is intended for setting by hand absolute minima and maxima. To restrict an efficiency between 80 and 100%, load the reference histogram with a mean of 0.9 (via HPAK) and the error bar of 0.1 (via HPAKE), and use HDIFFB with TOL=1.0 and the A option. The N option should also be selected for this application.

#### Comparison of Weighted versus Unweighted events:

This is in general undesirable, as it forces you into the less accurate Gaussian approximation. Thus it is preferable, for example, to have unweighted Monte Carlo events if you need to use HDIFFB to compare with data. The only useful case is if the weighted histogram is the reference histogram in the C comparison, which only makes sense if you have much better accuracy than your data.

**Using Profile histograms:**

The N option is irrelevant for profile histograms. The overflow/underflow options are illegal for profile histograms because insufficient information is stored to calculate the error bars. None of the test options (S, C, or A) check on the number of entries in a profile histogram bin. (To do that, make a separate 1-dimensional histogram.) This has an unexpected effect when the number of entries are small. Bins with no entries always pass the S and C options (no data is compatible with any distribution), so in such cases more bins pass than called for by TOL.

**Values of DIFFS:**

The value of DIFFS may depend somewhat on the value of TOL chosen, as the approximation chosen to calculate DIFFS depends on both the number of entries and on the size of TOL (how accurately DIFFS must be calculated).

The S option sometimes returns a confidence level of 1.0 in the small statistics calculation, i.e. there is no probability that the two numbers came from different distributions. This is due to finite precision. Values slightly higher than 1.0 will be returned when the two content values are identical, since no statistical test could claim they came from different distributions.

**Other notes:**

The normalization scaling (used unless N option selected) is based on channel contents for all channels requested (including overflow/underflow), provided you select one of the overflow/underflow options.

Negative bin contents are flagged as bad bins in S, C options.

**Statistical methods and numerical notes:**

(For simplicity, this is written as if the N option were in effect.)

The methods used for the S and C options are correct for unweighted events and Poisson statistics for 1- or 2- dimensional histograms. Errors may result in either the S and C options for small tolerances if bin contents are greater than the largest allowed integer.

For the S option with unweighted events, the test (which is uniformly most powerful) treats  $N = \text{sum of the two bin contents}$  as having chosen via a binomial distribution which histogram to enter. The binomial parameter  $p$  is given by the relative normalization of the histograms (0.5 if the total number of entries in each histogram was the same). For DIFFS values greater than TOL, the first two digits are correct. For values less than TOL, the two digits to the right of the first non-zero TOL digit are significant, i.e. for TOL=0.0001, 0.000xxx are significant. One can force higher accuracy by setting TOL smaller (or even 0), but calculation time will increase, and warning messages will be issued. A Gaussian approximation is used when there are 25 or more events in each bin, and TOL>0.001.

The C option for unweighted events in the data histogram simply calculates the Poisson probability of finding  $n$ , the ID2 bin value, given a mean equal to the bin value of ID1. A Gaussian approximation is used when the the mean is  $10^6$  or larger, and TOL is 0.001 or larger. Given the expected mean, the choice of TOL implies bounds ( $n_<$ ,  $n_>$ ) on  $n$  (i.e.  $n$  within these bounds passes). An error occurs when the approximations used in calculating DIFFS give an incorrect value for  $n_<$  or  $n_>$ . No such errors occur for mean  $< 10^5$  and TOL  $> 10^{-15}$ . The errors in  $n_<$  or  $n_>$  are less than 2 for mean  $< 10^6$ , TOL  $> 10^{-6}$ , or mean  $< 10^7$ , TOL  $> 10^{-5}$ . There is a maximum  $n$  beyond which DIFFS returns zero, so bins with  $n > n_{max}$  always fail. For mean  $< 10^7$ , this is irrelevant for values of TOL  $> 10^{-9}$ .

For the profile histogram S option, HDIFFB calculates the  $t$  test probability that both bin means were produced from a population with the same mean. The C option calculates the probability of finding the value in ID1 given a Gaussian with  $\mu$  and  $\sigma$  given by the ID2 contents. Small numbers of entries for either test give DIFFS values which are too large, and HDIFFB will reject too many events in profile histograms.

For weighted events, the S and C options use a Gaussian approximation. This results in DIFFS values which are too low. HDIFFB rejects too many bins for weighted events, particularly for small numbers of equivalent events.

### **Error messages of HDIFFB:**

Warning: Zero tolerance

The passed value TOL is less than or equal to 0. TOL=0. can be used to force highest accuracy in the S option.

Warning: Only one comparison at a time, please.

More than one type of comparison was selected. Only one of options S, C, and A may be used. The default S option will be used.

Warning: Different binning.

The XMIN values for a 1-dimensional histogram or the XMIN and/or YMIN values on a 2-dimensional histogram are different. This may give inaccurate results.

Warning: Weighted or saturated events in 2-dimensions.

HBOOK does not compute error bars for two dimensional histograms, thus weighted event are not allowed, and HDIFFB can not compute the correct statistics. An answer is still given, but it is probably not right. The only reliable case is a weighted 2-dimension histogram as the reference histogram for the C option.

Sum of histogram contents is zero!

The sum of the content bins is zero.

Histograms must be the same dimension.

A 1-dimensional and a 2-dimensional histogram have been specified. In order for the routine to work, both must be the same dimensionality.

Both histograms must be the standard or profile type.

Two different types of histograms have been specified. Both must be profile or non-profile. You cannot mix types.

Not enough bins in DIFFS to hold result.

The parameter NBINS is less than the number of bins in the histograms.

Number of channels is different.

The number of channels in the two histograms to compare are different. They must be the same before the routine will process the data.

U/O/L/R/T/B Option with weighted events.

HBOOK does not compute an error bar for over-/under-flow bins, thus it may not be used with weighted events.

U/O/L/R/T/B Option with profile histograms.

HBOOK does not compute an error bar for over-/under-flow bins, thus it may not be used with profile histograms.

Weighted options and no HBARX.

The user had not told HBOOK to figure the error bars for the histograms. Therefore, the operations will not be valid.

A-option with no error bars on reference histogram.

The user has not told HBOOK to compute error bars for the reference histogram. This error is also returned when the user attempts to select the A option to compare 2-dimensional histograms.

**Statistical comments:**

The methods used for the S and C mode are correct for unweighted events and Poisson statistics for one or two-dimensional histograms. For weighted events, a Gaussian approximation is used, which results in DIFFS values which are too low when there are fewer than 25 or so “equivalent events” (defined under HSTATI) per bin. This is caused by either few entries or by wide fluctuation in weights. The result is that HDIFFB rejects to many bins in this case.

Comparisons for profile histograms assume Gaussian statistics for the S and C mode comparisons of the channel mean. Fewer than 25 or so events will result in DIFFS values which are too large. The result is that HDIFFB rejects too many event in these low statistic cases.

## Chapter 7: Fitting, parameterization and smoothing

### 7.1 Fitting

The fitting routines in HBOOK are based on the Minuit package [12]. Minuit is conceived as a tool to find the minimum value of a multi-parameter function and analyze the shape of the function around the minimum. The principal application is foreseen for statistical analysis, working on chisquare or log-likelihood functions, to compute the best-fit parameter values and uncertainties, including correlations between the parameters. It is especially suited to handle difficult problems, including those which may require guidance in order to find the correct solution.

In the case of  $\chi^2$  minimization, the final fitted parameter values correspond to the minimum of the  $\chi^2$  function as defined below:

$$\chi^2 = \sum_{i=1}^n \left( \frac{C(I) - F(X(I), A_1, A_2, \dots, A_k)}{E(I)} \right)^2$$

where the following definitions are used:

n	Number of channels (cells) in the 1-dimensional or 2-dimensional histogram (HFITH, HFITHN) or number of points of the distribution (HFITV)
C(I)	Contents of channel (cell) I
E(I)	Error on C(I)
X(I)	Coordinate(s) of centre of channel (cell) I or coordinate vector of point I of the distribution
$A_1..A_k$	Parameters of the parametric function.
F	Parametric function to be fitted to the data points.

#### Remarks:

- If no errors are specified by the user, they are taken to be the square root of the bin contents. In this case:
  - empty channels are ignored by the fitting procedure;
  - If at least one of  $C(I) < 0$ , then  $E(I)$  is set to 1 for all channels (cells).
- If errors are correctly defined via HBARX or HPAKE, then all channels will be taken into account.

The minimization algorithm requires the calculation of derivatives of the function with respect to the parameters and this is normally done numerically by the fitting routine. If the analytical expression of the derivatives is known, the fit can be speeded up by making use of this information (see option D in the control flag of the various fitting routines).

For a log-likelihood fit, the likelihood is formed by determining the Poisson probability that given a number of entries in a particular bin, the fit would predict its value. This is then done for each bin, and the sum of the logs is taken as the likelihood.

### 7.1.1 One and two-dimensional distributions

```
CALL HFITH (ID,FUN,CHOPT,NP,*PARAM*,STEP,PMIN,PMAX,SIGPAR*,CHI2*)
```

**Action:** Fits a given parametric function to the contents of a 1- or 2-dimensional histogram, and optionally superimposes it to the 1-dimensional histogram when editing.

#### Input parameters:

ID	Histogram identifier.
FUN	Parametric function (to be declared EXTERNAL, see 7.1.5) Can be defined interactively in the interactive version (see paw manual)
CHOPT	Character variable specifying the desired options. <ul style="list-style-type: none"> <li>'B' Some or all parameters are bounded. The arrays STEP, PMIN and PMAX must be specified. By default all parameters vary freely.</li> <li>'D' The user specifies the derivatives of the function analytically by providing the user routine HDERIV. By default derivatives are computed numerically.</li> <li>'E' Perform a detailed error analysis using the MINUIT routines HESSE and MINOS</li> <li>'F' Force storing of the result of the fit bin by bin with the histogram for an any-dimensional histogram.</li> <li>'K' 'KM' means: do to reset the parameters of Application HMINUIT.</li> <li>'L' Use the logarithmic Likelihood fitting method. By default the chisquared method is used.</li> <li>'M' Invoke interactive MINUIT.</li> <li>'N' The results of the fit are not stored bin by bin with the histogram. By default the function is calculated at the centre of each bin in the specified range.</li> <li>'Q' Quiet mode. No printing.</li> <li>'R' Fit a Restricted area of a 1-D or 2-D histogram. The limits for the fit are given using in the vector IQUEST is in the communication common /QUEST/IQUEST(100), as follows: IFXLOW = IQUEST(11) specifies the lower limit in X, IFXUP = IQUEST(12) specifies the upper limit in X, IFYLOW = IQUEST(13) specifies the lower limit in Y (2-D), IFYUP = IQUEST(14) specifies the upper limit in Y (2-D).</li> <li>'U' User function value is taken from /HCFITD/FITPAD(24),FITFUN, see section 7.1.5. All calculations are performed in double precision.</li> <li>'V' Verbose mode. Results are printed after each iteration. By default only final results are printed.</li> <li>'W' Set the event weights equal to one. By default weights are taken according to statistical errors.</li> </ul>
NP	Number of parameters ( $NP \leq 25$ ).
PARAM	Array of dimension NP with initial values for the parameters.
STEP	Array of dimension NP with initial step sizes for the parameters ('B' option only).
PMIN	Array of dimension NP with the lower bounds for the parameters ('B' option only).
PMAX	Array of dimension NP with the upper bounds for the parameters ('B' option only).

**Output parameters:**

PARAM Array of dimension NP with the final fitted values of the parameters.

SIGPAR Array of dimension NP with the standard deviations on the final fitted values of the parameters.

CHI2 Chisquared of the fit.

**7.1.2 Fitting one-dimensional histograms with special functions**

```
CALL HFITHN (ID,CHFUN,CHOPT,NP,*PAR*,STEP,PMIN,PMAX,SIGPAR*,CHI2*)
```

**Action:** Fits the given special function to the contents of a one-dimensional histogram, and optionally superimposes it to the histogram when editing.

**Input parameters:**

ID Histogram identifier.

CHFUN Character variable specifying the desired parametric function. Possible keywords are:

G to fit gaussian  $\text{PAR}(1) \cdot \exp(-0.5 \cdot ((x - \text{PAR}(2)) / \text{PAR}(3))^2)$ .  
 PAR(1) corresponds to the normalization,  
 PAR(2) corresponds to the mean value, and  
 PAR(3) corresponds to the half width of the Gaussian.

E to fit exponential  $\exp(\text{PAR}(1) + \text{PAR}(2) \cdot x)$

Pn to fit polynomial  $\text{PAR}(1) + \text{PAR}(2) \cdot x + \text{PAR}(3) \cdot x^2 + \dots + \text{PAR}(n+1) \cdot x^n$

Any combination of these keywords with the 2 operators + or \* is allowed, e.g. 'p4+g', a combination of a 4th degree polynomial and a gaussian, which needs eight parameters or p2\*g+g, a second degree polynomial and 2 gaussians, needing 9 parameters. The order of the parameters in PAR must correspond to the order of the basic functions. For example, in the first case above, PAR(1:5) apply to the polynomial of degree 4 and PAR(6:8) to the gaussian while in the second case PAR(1:3) apply to the polynomial of degree 2, PAR(4:6) to the first gaussian and PAR(7:9) to the second gaussian. Blanks are not allowed in the expression.

CHOPT 'B' Some or all parameters are bounded. The arrays STEP, PMIN and PMAX must be specified. By default all parameters vary freely.

'D' The user is assumed to compute derivatives analytically using the routine HDERIV. By default, derivatives are computed numerically.

'E' Perform a detailed error analysis using the `minuit` routines HESSE and MINOS

'F' Force storing of the result of the fit bin by bin with the histogram.

'L' Use the logarithmic Likelihood fitting method. By default the chisquared method is used.

'M' Invoke interactive `minuit`.

'N' The results of the fit are not stored bin by bin with the histogram. By default the function is calculated at the centre of each bin in the specified range.

'Q' Quiet mode. No printing.

'R' Fit a Restricted area of the 1-D histogram. IFTLOW = IQUEST(11) specifies the lower limit of the minimization domain,  
 IFTUP = IQUEST(12) specifies the upper limit of the minimization domain.



'V'	Verbose mode. Results are printed after each iteration. By default only final results are printed.
'W'	Set event weights to one. By default weights are taken according to statistical errors.
NP	Number of parameters.
PAR	Array of dimension NP with initial values for the parameters.
STEP	Array of dimension NP with initial step sizes for the parameters ('B' option only).
PMIN	Array of dimension NP with the lower bounds for the parameters ('B' option only).
PMAX	Array of dimension NP with the upper bounds for the parameters ('B' option only).

**Output parameters:**

PAR	Array of dimension NP with the final fitted values of the parameters.
SIGPAR	Array of dimension NP with the standard deviations on the final fitted values of the parameters.
CHI2	Chisquared of the fit.

**7.1.3 Fitting one or multi-dimensional arrays**

```
CALL HFITV (N,NDIM,NVAR,X,Y,EY,FUN,CHOPT,NP,*PAR*,STEP,PMIN,PMAX,SIGPAR*,
           CHI2*)
```

**Action:** Fits a given parametric function to a number of value pairs with associated errors.

**Input parameters:**

N	Number of points to be fitted.
NDIM	Declared first dimension of array X.
NVAR	Dimension of the distribution.
X	Array of dimension N containing the X-coordinates of the points to be fitted.
Y	Array of dimension N containing the Y-coordinates of the points to be fitted.
EY	Array of dimension N containing the errors on the Y-coordinates of the points to be fitted.
FUN	Parametric function (to be declared EXTERNAL)
CHOPT	Character variable specifying the desired options.
'B'	Some or all parameters are bounded. The arrays STEP, PMIN and PMAX must be specified. By default all parameters vary freely.
'D'	The user provides the derivatives of the function analytically by specifying the user routine HDERIV. By default derivatives are computed numerically.
'E'	Perform a detailed error analysis using the <code>minuit</code> routines
'L'	Use the logarithmic Likelihood fitting method. By default the chisquared method is used.
'M'	Invoke interactive MINUIT.
'Q'	Quiet mode. No printing.
'U'	User function value is taken from <code>/HCFITD/FITPAD(24)</code> , FITFUN, see section 7.1.5. All calculations are performed in double precision.

'V'	Verbose mode. Results are printed after each iteration. By default only final results are printed.
'W'	Set the event weights equal to one. By default weights are taken according to statistical errors. HESSE and MINOS
NP	Number of parameters ( $NP \leq 25$ ).
PAR	Array of dimension NP with initial values for the parameters.
STEP	Array of dimension NP with initial step sizes for the parameters ('B' option only).
PMIN	Array of dimension NP with the lower bounds for the parameters ('B' option only).
PMAX	Array of dimension NP with the upper bounds for the parameters ('B' option only).

#### Output parameters:

PAR	Array of dimension NP with the final fitted values of the parameters.
SIGPAR	Array of dimension NP with the standard deviations on the final fitted values of the parameters.
CHI2	Chisquared of the fit.

#### 7.1.4 Results of the fit

When the fit is complete, the parameters and the errors on the parameters are returned to the calling program. By default (unless option 'N' is specified), the fitted parameters, the errors on these parameters, their names (see below), the chi-squared and the number of degrees of freedom of the fit are stored in a data structure associated to the histogram ID when routines HFITH and HFITHN are invoked.

- For HFITH the value of the fitted function in each histogram channel is also stored in the histogram data structure. The parameters are given the default names: P1, P2, ..., Pn.
- For HFITHN the type of the function being fitted is stored instead of the fitted values for each channel.

The information stored in the associated data structure is used during the printing/plotting phase. In particular it is written when the histogram is stored in a file with HROUT.

#### Naming the parameters of a fit

```
CALL HFINAM (ID, CHPNAM, NPAR)
```

**Action:** Modify the names of the fitted parameters in the data structure associated with the given histogram.

#### Input parameter:

ID	Histogram identifier.
CHPNAM	CHARACTER array specifying the name(s) to be given to the parameter(s) of the fit (truncated to 8 characters).
NPAR	Number of parameters specified.

## Retrieving the fitted parameters

```
CALL HGFIT (ID,NFPAR*,NPFITS*,FITCHI*,FITPAR*,FITSIG*,FITNAM*)
```

**Action:** Retrieve the fitted parameters values from the data structure associated with a given histogram.

### Input parameter:

ID Histogram identifier.

### Output parameters:

NFPAR Number of parameters.

NPFITS Number of data points used in the fit.

FITCHI  $\chi^2$  of the fit.

FITPAR Array of dimension at least NFPAR, containing the value of the fitted parameters.

FITSIG Array of dimension at least NFPAR, containing the standard deviations of values of the fitted parameters.

FITNAM Character array of dimension at least NFPAR, containing the names of the fitted parameters (truncated to 8 characters). See also HFINAM above.

### 7.1.5 The user parametric function

When routines HFITH and HFITV are invoked, a user parametric function FUN, specified as an argument to those routines, is called during the minimization procedure.

If the 'U' option is specified with these routines, the user function is calculated in double precision (in the case of HFITHN with the predefined functions (G, E, Pn) double precision is always used). In this case you must reference the common block /HCFITD/, which contains the parameter values in double precision, and store the resulting function value in variable FITFUN, as shown in the example below.

#### Example of user function in double precision

```
FUNCTION UFIT(X)
*   The dimension of DPAR  ||  MUST be 24!
*                               VV
  DOUBLE PRECISION DPAR(24),FITFUN
  COMMON/HCFITD/DPAR,FITFUN
  FITFUN = DPAR(1)+DPAR(2)*SQRT(X) +DPAR(3)/X
  UFIT=FITFUN
  END
```

Even if you do not want to use a double precision function value (i.e. you do not specify the 'U' option), you should still compute the fit function as accurately as possible, using double precision variables in strategic places. This function should also be protected against possible arithmetic exception conditions, like under or overflows and negative arguments for square roots or logarithms.

## User specified derivatives

```
CALL HDERIV (DERIV)
```

**Action:** User provided subroutine, which calculates the derivatives of the parameters of the function being fitted. This routine must be called from the user function FUN when option 'D' is selected with HFITH or HFITN.

### Input parameter:

DERIV Array containing the derivatives of the function being fitted.

## 7.2 Basic concepts of MINUIT

The `minuit` package acts on a multiparameter Fortran function to which one must give the generic name FCN. In the `paw/hbook` implementation, the function FCN is called HFCNH when the command Histo/Fit (`paw`) or the routine HFITH are invoked. It is called HFCNV when the command Vector/Fit or the routine HFITV are invoked. The value of FCN will in general depend on one or more variable parameters.

To take a simple example, suppose the problem is to fit a polynomial through a set of data points with the command Vector/Fit. Routine HFCNV called by HFITV calculates the chisquare between a polynomial and the data; the variable parameters of HFCNV would be the coefficients of the polynomials. Routine HFITV will request MINUIT to minimize HFCNV with respect to the parameters, that is, find those values of the coefficients which give the lowest value of chisquare.

### 7.2.1 Basic concepts - The transformation for parameters with limits.

For variable parameters with limits, MINUIT uses the following transformation:

$$P_{\text{int}} = \arcsin \left( 2 \frac{P_{\text{ext}} - a}{b - a} - 1 \right) \qquad P_{\text{ext}} = a + \frac{b - a}{2} (\sin P_{\text{int}} + 1)$$

so that the internal value  $P_{\text{int}}$  can take on any value, while the external value  $P_{\text{ext}}$  can take on values only between the lower limit  $a$  and the upper limit  $b$ . Since the transformation is necessarily non-linear, it would transform a nice linear problem into a nasty non-linear one, which is the reason why limits should be avoided if not necessary. In addition, the transformation does require some computer time, so it slows down the computation a little bit, and more importantly, it introduces additional numerical inaccuracy into the problem in addition to what is introduced in the numerical calculation of the FCN value. The effects of non-linearity and numerical roundoff both become more important as the external value gets closer to one of the limits (expressed as the distance to nearest limit divided by distance between limits). The user must therefore be aware of the fact that, for example, if he puts limits of  $(0, 10^{10})$  on a parameter, then the values 0.0 and 1.0 will be indistinguishable to the accuracy of most machines.

The transformation also affects the parameter error matrix, of course, so MINUIT does a transformation of the error matrix (and the “parabolic” parameter errors) when there are parameter limits. Users should however realize that the transformation is only a linear approximation, and that it cannot give a meaningful result if one or more parameters is very close to a limit, where  $\partial P_{\text{ext}} / \partial P_{\text{int}} \approx 0$ . Therefore, it is recommended that:

- Limits on variable parameters should be used only when needed in order to prevent the parameter from taking on unphysical values.
- When a satisfactory minimum has been found using limits, the limits should then be removed if possible, in order to perform or re-perform the error analysis without limits.

### 7.2.2 How to get the right answer from MINUIT

MINUIT offers the user a choice of several minimization algorithms. The MIGRAD (Other algorithms are available with Interactive MINUIT, as described on Page 119) algorithm is in general the best minimizer for nearly all functions. It is a variable-metric method with inexact line search, a stable metric updating scheme, and checks for positive-definiteness. Its main weakness is that it depends heavily on knowledge of the first derivatives, and fails miserably if they are very inaccurate. If first derivatives are a problem, they can be calculated analytically inside the user function and communicated to `parw` via the routine `HDERIV`.

If parameter limits are needed, in spite of the side effects, then the user should be aware of the following techniques to alleviate problems caused by limits:

#### Getting the right minimum with limits.

If MIGRAD converges normally to a point where no parameter is near one of its limits, then the existence of limits has probably not prevented MINUIT from finding the right minimum. On the other hand, if one or more parameters is near its limit at the minimum, this may be because the true minimum is indeed at a limit, or it may be because the minimizer has become “blocked” at a limit. This may normally happen only if the parameter is so close to a limit (internal value at an odd multiple of  $\pm \frac{\pi}{2}$ ) that MINUIT prints a warning to this effect when it prints the parameter values.

The minimizer can become blocked at a limit, because at a limit the derivative seen by the minimizer  $\partial F / \partial P_{\text{int}}$  is zero no matter what the real derivative  $\partial F / \partial P_{\text{ext}}$  is.

$$\frac{\partial F}{\partial P_{\text{int}}} = \frac{\partial F}{\partial P_{\text{ext}}} \frac{\partial P_{\text{ext}}}{\partial P_{\text{int}}} = \frac{\partial F}{\partial P_{\text{ext}}} = 0$$

#### Getting the right parameter errors with limits.

In the best case, where the minimum is far from any limits, MINUIT will correctly transform the error matrix, and the parameter errors it reports should be accurate and very close to those you would have got without limits. In other cases (which should be more common, since otherwise you wouldn’t need limits), the very meaning of parameter errors becomes problematic. Mathematically, since the limit is an absolute constraint on the parameter, a parameter at its limit has no error, at least in one direction. The error matrix, which can assign only symmetric errors, then becomes essentially meaningless.

### 7.2.3 Interpretation of Parameter Errors:

There are two kinds of problems that can arise: the **reliability** of MINUIT’s error estimates, and their **statistical interpretation**, assuming they are accurate.

#### Statistical interpretation:

For discussion of basic concepts, such as the meaning of the elements of the error matrix, or setting of exact confidence levels (see [11]).

### Reliability of MINUIT error estimates.

MINUIT always carries around its own current estimates of the parameter errors, which it will print out on request, no matter how accurate they are at any given point in the execution. For example, at initialization, these estimates are just the starting step sizes as specified by the user. After a MIGRAD or HESSE step, the errors are usually quite accurate, unless there has been a problem. MINUIT, when it prints out error values, also gives some indication of how reliable it thinks they are. For example, those marked `CURRENT GUESS ERROR` are only working values not to be believed, and `APPROXIMATE ERROR` means that they have been calculated but there is reason to believe that they may not be accurate.

If no mitigating adjective is given, then at least MINUIT believes the errors are accurate, although there is always a small chance that MINUIT has been fooled. Some visible signs that MINUIT may have been fooled are:

- Warning messages produced during the minimization or error analysis.
- Failure to find new minimum.
- Value of EDM too big (estimated Distance to Minimum).
- Correlation coefficients exactly equal to zero, unless some parameters are known to be uncorrelated with the others.
- Correlation coefficients very close to one (greater than 0.99). This indicates both an exceptionally difficult problem, and one which has been badly parameterized so that individual errors are not very meaningful because they are so highly correlated.
- Parameter at limit. This condition, signalled by a MINUIT warning message, may make both the function minimum and parameter errors unreliable. See the discussion above “*Getting the right parameter errors with limits*”.

The best way to be absolutely sure of the errors, is to use “independent” calculations and compare them, or compare the calculated errors with a picture of the function. Theoretically, the covariance matrix for a “physical” function must be positive-definite at the minimum, although it may not be so for all points far away from the minimum, even for a well-determined physical problem. Therefore, if MIGRAD reports that it has found a non-positive-definite covariance matrix, this may be a sign of one or more of the following:

**A non-physical region:** On its way to the minimum, MIGRAD may have traversed a region which has unphysical behaviour, which is of course not a serious problem as long as it recovers and leaves such a region.

**An underdetermined problem:** If the matrix is not positive-definite even at the minimum, this may mean that the solution is not well-defined, for example that there are more unknowns than there are data points, or that the parameterization of the fit contains a linear dependence. If this is the case, then MINUIT (or any other program) cannot solve your problem uniquely, and the error matrix will necessarily be largely meaningless, so the user must remove the underdeterminedness by reformulating the parameterization. MINUIT cannot do this itself.

**Numerical inaccuracies:** It is possible that the apparent lack of positive-definiteness is in fact only due to excessive roundoff errors in numerical calculations in the user function or not enough precision. This is unlikely in general, but becomes more likely if the number of free parameters is very large, or if the

parameters are badly scaled (not all of the same order of magnitude), and correlations are also large. In any case, whether the non-positive-definiteness is real or only numerical is largely irrelevant, since in both cases the error matrix will be unreliable and the minimum suspicious.

**An ill-posed problem:** For questions of parameter dependence, see the discussion above on positive-definiteness.

Possible other mathematical problems are the following:

**Excessive numerical roundoff:** Be especially careful of exponential and factorial functions which get big very quickly and lose accuracy.

**Starting too far from the solution:** The function may have unphysical local minima, especially at infinity in some variables.

#### 7.2.4 MINUIT interactive mode

With the routines HFITH or HFITV and the M option, HBOOK goes into interactive mode and gives control to the MINUIT program. In this case, the user may enter MINUIT control statements directly.

#### Overview of available MINUIT commands

##### CLEAr

Resets all parameter names and values to undefined. Must normally be followed by a PARAMETER command or equivalent, in order to define parameter values.

##### CONtour par1 par2 [devs] [ngrid]

Instructs MINUIT to trace contour lines of the user function with respect to the two parameters whose external numbers are **par1** and **par2**. Other variable parameters of the function, if any, will have their values fixed at the current values during the contour tracing. The optional parameter [**devs**] (default value 2.) gives the number of standard deviations in each parameter which should lie entirely within the plotting area. Optional parameter [**ngrid**] (default value 25 unless page size is too small) determines the resolution of the plot, i.e. the number of rows and columns of the grid at which the function will be evaluated.

##### EXIT

End of Interactive MINUIT. Control is returned to paw.

##### FIX parno

Causes parameter **parno** to be removed from the list of variable parameters, and its value will remain constant (at the current value) during subsequent minimizations, etc., until another command changes its value or its status.

##### HELP [SET] [SHOw]

Causes MINUIT to list the available commands. The list of SET and SHOw commands must be requested separately.

**HESse** [**maxcalls**]

Instructs MINUIT to calculate, by finite differences, the Hessian or error matrix. That is, it calculates the full matrix of second derivatives of the function with respect to the currently variable parameters, and inverts it, printing out the resulting error matrix. The optional argument [**maxcalls**] specifies the (approximate) maximum number of function calls after which the calculation will be stopped.

**IMProve** [**maxcalls**]

If a previous minimization has converged, and the current values of the parameters therefore correspond to a local minimum of the function, this command requests a search for additional distinct local minima. The optional argument [**maxcalls**] specifies the (approximate) maximum number of function calls after which the calculation will be stopped.

**MIGrad** [**maxcalls**] [**tolerance**]

Causes minimization of the function by the method of Migrad, the most efficient and complete single method, recommended for general functions (see also MINimize). The minimization produces as a by-product the error matrix of the parameters, which is usually reliable unless warning messages are produced. The optional argument [**maxcalls**] specifies the (approximate) maximum number of function calls after which the calculation will be stopped even if it has not yet converged. The optional argument [**tolerance**] specifies required tolerance on the function value at the minimum. The default tolerance is 0.1. Minimization will stop when the estimated vertical distance to the minimum (EDM) is less than  $0.001 * [\text{tolerance}] * \text{UP}$  (see SET ERR).

**MINimize** [**maxcalls**] [**tolerance**]

Causes minimization of the function by the method of Migrad, as does the MIGrad command, but switches to the SIMplex method if Migrad fails to converge. Arguments are as for MIGrad.

**MINOs** [**maxcalls**] [**parno**] [**parno**]...

Causes a Minos error analysis to be performed on the parameters whose numbers [**parno**] are specified. If none are specified, Minos errors are calculated for all variable parameters. Minos errors may be expensive to calculate, but are very reliable since they take account of non-linearities in the problem as well as parameter correlations, and are in general asymmetric. The optional argument [**maxcalls**] specifies the (approximate) maximum number of function calls *per parameter requested*, after which the calculation will be stopped for that parameter.

**RELease** **parno**

If **parno** is the number of a previously variable parameter which has been fixed by a command: **FIX parno**, then that parameter will return to variable status. Otherwise a warning message is printed and the command is ignored. Note that this command operates only on parameters which were at one time variable and have been **FIXed**. It cannot make constant parameters variable; that must be done by redefining the parameter with a **PARAMETER** command.



**REStore [code]**

If no **[code]** is specified, this command restores all previously **FIXed** parameters to variable status. If **[code]=1**, then only the last parameter **FIXed** is restored to variable status.

**SCAN [parno] [numpts] [from] [to]**

Scans the value of the user function by varying parameter number **[parno]**, leaving all other parameters fixed at the current value. If **[parno]** is not specified, all variable parameters are scanned in sequence. The number of points **[numpts]** in the scan is 40 by default, and cannot exceed 100. The range of the scan is by default 2 standard deviations on each side of the current best value, but can be specified as from **[from]** to **[to]**. After each scan, if a new minimum is found, the best parameter values are retained as start values for future scans or minimizations. The curve resulting from each scan is plotted on the output unit in order to show the approximate behaviour of the function. This command is not intended for minimization, but is sometimes useful for debugging the user function or finding a reasonable starting point.

**SEEk [maxcalls] [devs]**

Causes a Monte Carlo minimization of the function, by choosing random values of the variable parameters, chosen uniformly over a hypercube centered at the current best value. The region size is by default 3 standard deviations on each side, but can be changed by specifying the value of **[devs]**.

**SET ERRordef up**

Sets the value of **up** (default value= 1.), defining parameter errors. MINUIT defines parameter errors as the change in parameter value required to change the function value by **up**. Normally, for chisquared fits **up=1**, and for negative log likelihood, **up=0.5**.

**SET LIMits [parno] [lolim] [uplim]**

Allows the user to change the limits on one or all parameters. If no arguments are specified, all limits are removed from all parameters. If **[parno]** alone is specified, limits are removed from parameter **[parno]**. If all arguments are specified, then parameter **[parno]** will be bounded between **[lolim]** and **[uplim]**. Limits can be specified in either order, MINUIT will take the smaller as **[lolim]** and the larger as **[uplim]**. However, if **[lolim]** is equal to **[uplim]**, an error condition results.

**SET PARAmeter parno value**

Sets the value of parameter **parno** to **value**. The parameter in question may be variable, fixed, or constant, but must be defined.

**SET PRIntout level**

Sets the print level, determining how much output MINUIT will produce. The allowed values and their meanings are displayed after a **SHOW PRInt** command. Possible values for **level** are:

- 1 No output except from **SHOW** commands
- 0 Minimum output (no starting values or intermediate results)

- 1 Default value, normal output
- 2 Additional output giving intermediate results.
- 3 Maximum output, showing progress of minimizations.

### SET STRategy level

Sets the strategy to be used in calculating first and second derivatives and in certain minimization methods. In general, low values of **level** mean fewer function calls and high values mean more reliable minimization. Currently allowed values are 0, 1 (default), and 2.

### SHOw XXXX

All **SET XXXX** commands have a corresponding **SHOw XXXX** command. In addition, the **SHOw** commands listed starting here have no corresponding **SET** command for obvious reasons. The full list of **SHOw** commands is printed in response to the command **HELP SHOw**.

### SHOw CORe relations

Calculates and prints the parameter correlations from the error matrix.

### SHOw COVariance

Prints the (external) covariance (error) matrix.

### SIMplex [maxcalls] [tolerance]

Performs a function minimization using the simplex method of Nelder and Mead. Minimization terminates either when the function has been called (approximately) [maxcalls] times, or when the estimated vertical distance to minimum (EDM) is less than [tolerance]. The default value of [tolerance] is 0.1\*UP (see SET ERR).

## 7.3 Deprecated fitting routines

### Fitting histograms – Long version

```
CALL HFITL (ID,FUN,NP,*P*,CHI2*,IC,SIG*,COV*,ST,PMI,PMA)
```

Use HFITH instead.

### Fitting histograms – Short version

```
CALL HFITS (ID,FUN,NP,*P*,CHI2*,IC,SIG*)
```

Use HFITH instead.

### Non-equidistant points in a multi-dimensional space – Long version

```
CALL HFITN (X,Y,EY,NPTS,N1,NVAR,FUN,NP,*P*,CHI2*,IC,SIG*,COV*)
```

Use HFITV instead.

**Non-equidistant points in a multi-dimensional space – Short version**

```
CALL HFIT1 (X,Y,EY,N,FUN,NP,*P*,CHI2*,IC,SIG*)
```

Use HFITV instead.

**Histogram Fitting with Special Functions**

```
CALL HFITEX (ID,AA*,BB*,CHI2*,IC,SIG*)
```

Use HFITHN instead as CALL HFITHN(ID,'E',',',2,PAR,STEP,PMIN,PMAX,SIGPAR,CHI2).

```
CALL HFITGA (ID,C*,AV*,SD*,CHI2*,IC,SIG*)
```

Use HFITHN instead as CALL HFITHN(ID,'G',',',3,PAR,STEP,PMIN,PMAX,SIGPAR,CHI2).

```
CALL HFITPO (ID,NP,A*,CHI2*,IC,SIG*)
```

Use HFITHN instead as CALL HFITHN(ID,'Pn',',',NP,PAR,STEP,PMIN,PMAX,SIGPAR,CHI2), where  $n=NP-1$  in the second argument 'Pn'.

**7.4 Parametrization**

In analyzing experimental data, it is sometimes very important to be able to **parametrize** relationships among data by means of linear combinations of **elementary** functions. One of these **expansions** is the well known Taylor series which is an expansion of an analytic function using as elementary functions (regressors) the powers of the independent variables. In the case of the Taylor series, the coefficients of the linear combination are a well known expression involving the derivatives of the function to be represented at a given (initial) point. Even if the Taylor series is very powerful for its noticeable features and its analytical simplicity, from the point of view of the numerical analyst it might be not the best expansion in terms of elementary functions. Ideally one would like to use the smallest possible number of regressors, in order to describe the relationship among data with a given precision, and this is not always guaranteed using the Taylor series. Another feature of the monomials is that they do not form a complete orthonormal set of functions, in the sense of the Hilbert spaces, while other functions, which possess this feature, may be more computationally convenient to use.

The entries HPARAM (for histograms and scatter plots) and HPARMN (for n-dimensional distributions) perform regressions on the data in order to find the best parametrization in terms of elementary functions (regressors).

Let us suppose that we have collected NP sets of NDIM+1 data, being  $(y_i, x_{1,i} \dots x_{NDIM,i})$  with  $1 \leq i \leq NP$  the  $i^{th}$  set. Here  $y_i$  is the value observed at the coordinates  $x_{1,i} \dots x_{NDIM,i}$ . NDIM must be greater or equal to 1 and it is the **dimensionality** of our parametrization problem, that is the number of independent variables that we want to use in order to parametrize our data. In the case of a histogram NDIM is clearly 1,  $x$  is the centre of a histogram channel,  $y$  is the contents of the corresponding channel and NP is the number of channels of the histogram. In the case of a scatter plot NDIM is 2,  $x_1$  and  $x_2$  are the ordinate and abscissa of the centre of a cell,  $y$  is the contents of the cell and NP is  $NX*NY$ , the total number of cells. In case of histograms or scatter plots the entry HPARAM should be used. For data which are not contained in an

HBOOK histogram or scatter plot and for higher dimensionality sets ( $NDIM \leq 10$ ) the entry HPARMN has to be used. We could express a possible expansion of our data in elementary functions in the following way:

$$\begin{aligned}
 y_1 &= c_1 * F_1(x_{1,1}, \dots, x_{NDIM,1}) + \dots \\
 &\quad + c_{NCO} * F_{NCO}(x_{1,1}, \dots, x_{NDIM,1}) + u_1 \\
 &\quad \vdots \\
 y_{NP} &= c_1 * F_1(x_{1,NP}, \dots, x_{NDIM,NP}) + \dots \\
 &\quad + c_{NCO} * F_{NCO}(x_{1,NP}, \dots, x_{NDIM,NP}) + u_{NP}
 \end{aligned}$$

where we are summing NCO elementary functions each one multiplied by its own coefficient. In other words we are pretending that our data points are **fitted** by the given expansion but for a residual, namely  $u_j$ . The expansion itself is the linear combination of the **regressors**  $F_j$  computed at the  $j^{th}$  data point. The strategy of the two entries is to minimize the residual variance from fitting various possible regressors out of a set which is either system or user-defined. The previous expression can be rewritten in a more synthetical notation:

$$\begin{array}{l}
 y = Fc + u \quad \text{with} \\
 \begin{array}{l}
 y \quad \text{array of NP data points} \\
 F \quad \text{matrix of regressors (NP lines times NCO columns)} \\
 c \quad \text{array of NCO coefficients} \\
 u \quad \text{array for the NP residuals}
 \end{array}
 \end{array}$$

As already said, we want to use the smallest possible number of regressors for a given set of data points, which yields the desired fit (in the terms explained below). That is to say that the rank of the matrix  $F$  should be NCO. If it were smaller, then some (at least one) of the columns could be represented as a linear combination of others, and so, rearranging the coefficients, we could get rid of these regressors.

The residual variance is minimized under the following constraints:

- 1 The NP values of the residuals should have a mean of 0.
- 2 The residuals should be independently distributed. This means that their covariance matrix has the form of a positive diagonal matrix (we call it D).
- 3 The regressors should be linearly independent.

Hypothesis 2 implies that  $(F^t F)^{-1}$  exists, where  $D(F^t F)^{-1}$  is the **covariance matrix** of the coefficients.

The coefficients and regressors are determined iteratively until the convergence criteria for the fit are reached. The user has the choice to specify that the criteria are met either when the residual variance stops decreasing or when the multiple correlation coefficient reaches the value specified via the input parameter R2MIN (see later). Once the list of all possible regressors has been established, at each step the one which gives the highest drop in the residual sum of squares is added to the expansion. In addition, all previously chosen regressors are tested for possible rejection, using standard test statistics (F-tests), as it can happen that a regressor becomes superfluous at a later stage of the fitting process.

The routines offer three choices for the regressors: standard elementary functions, user-given elementary functions or user-given regressors. In the first two cases each regressor is the product of NDIM elementary functions, one for each variable (the constant function may be included in the set). This means that in the first two cases we will have a **matrix** of  $NDIM * NCO$  elementary functions, and the array of regressors will be the result of the scalar product of the NDIM columns of this matrix. In the last case each regressor

is user-defined, and we have just  $NC0$  regressors to be specified as user functions (see below). The  $NC0$  regressors have to be linearly combined with the  $NC0$  coefficients contained in the output array `COEFF` to obtain the parametrization. Each elementary function, either standard or user-defined is identified by a three digit code, let's say  $nnm$ . The last digit,  $m$ , is a one digit code specifying the kind of regressor used, with the following meaning:

- 0 Standard elementary function
- 1 User-provided elementary function
- 2 User-provided regressor

The first two digits define the function number. In the first two cases, we have  $NDIM*NC0$  of these codes arranged in an array, so that the first  $NDIM$  codes are the code of the elementary functions to be multiplied to obtain the first regressor. For system defined elementary functions  $nn$  is the degree of the polynomial. For user-provided regressors, the meaning of this code is user-defined, in the sense that the user is free to give any meaning he wishes to this code in the routine he has to supply. In the case of user-provided regressors, we will have just  $NC0$  regressor codes in the array `ITERM` at the end of the fitting process. Only one code is needed to define a user-given regressor, whereas  $NDIM$  codes are needed to specify a regressor composed of elementary functions.

The parametrization routines will select the most efficient subset of regressors out of the set selected by the user, in the sense of the criteria specified above.

Once the initial set of regressors has been specified, the user still has the opportunity to tell the system how to make a further selection among those regressors, before the fitting process actually starts:

- The maximum degrees of the standard polynomials for each independent variable are given by `MAXPOW` (array of dimension  $NDIM$ ). This input parameter is mandatory and there is no default provided for it.
- The total degree of a regressor made up from the product of standard polynomials, may be limited by setting `PSEL` (via `HSETPR`) to a positive value  $<NDIM$ . `PSEL` controls the exclusion of the combinations of standard polynomials which give the higher order regressors (see the description of this parameter).
- Each initial regressor, whose code is passed to the logical function `HSELBF`, written by the user, may be accepted or rejected according to user criteria
- The argument `ITERM` (under control of `IC` below) may be used as input to the routines to contain the list of the codes of the acceptable regressors.

As soon as the best parametrization is obtained, the user may call the function `HRVAL(X)`, which is of type `DOUBLE PRECISION` and which returns the value of the parametrization, computed at point  $X$ , where  $X$  is an array of dimension  $NDIM$ .

The program can handle up to 10 dimensions (i.e.  $NDIM \leq 10$ ) Up to 50 regressors may appear in the final expression. This is controlled by the `PNCX` parameter set by the routine `HSETPR` (see below).

Memory requirements: a 1-dimensional histogram with 100 channels and with the maximum number of regressors `PNCX` set to 10, requires in `DOUBLE PRECISION` version, less than 5000 words; for large values of `PNCX` and a large number of points, memory behaves roughly as  $2*NP*PNCX$  (`DOUBLE PRECISION`).

## Histograms and plots

```
CALL HPARAM (ID, IC, R2MIN, MAXPOW, COEFF*, ITERM*, NCO*)
```

### Input parameters:

- ID Histogram or plot identifier.
- IC Control word (see below)
- R2MIN Maximum required value of multiple correlation coefficient
- MAXPOW Maximum degrees of standard polynomials (INTEGER array of size NDIM)
- ITERM Acceptable function codes (see explanation above) (INTEGER array of size  $\leq$ PNBF, see explanation above)

### Output parameters:

- NCO number of regressors in final expression.
- COEFF Coefficients of terms (DOUBLE PRECISION array of size NCO)
- ITERM Accepted regressors codes (INTEGER array of size NDIM\*NCO or NCO, see explanation above)

IC is a coded integer with the following fields:

$$IC = N * 10^7 + R * 10^6 + C * 10^5 + B * 10^4 + T * 10^3 + W * 10^2 + P * 10 + S$$

- S This switch controls the superimposition of the result when printing the histogram, it is effective only for 1-dimensional histograms
- 1 Resulting parametric fit superimposed on histogram
  - 0 No superposition
- P This switch controls the amount of information printed during the fitting process
- 0 Minimal output: the residual sum of squares is printed
  - 1 Normal output: in addition, the problem characteristics and options are printed; also the standard deviations and confidence intervals of the coefficients
  - 2 extensive output: the results of each iteration are printed with the normal output
- W This switch controls the weights to applied to the data during the fit
- 0 weights on histogram contents are already defined via HBARX or HPAKE. If not they are taken to be equal to the square-root of the contents
  - 1 weights are equal to 1
- T This switch controls the system-defined elementary functions set to use
- 0 Monomials will be selected as the standard elementary functions
  - 1 Chebyshev polynomials with a definition region:  $[-1, 1]$
  - 2 Legendre polynomials with a definition region:  $[-1, 1]$
  - 3 shifted Chebyshev polynomials with a definition region:  $[0, 1]$
  - 4 Laguerre polynomials with a definition region:  $[0, +\infty]$
  - 5 Hermite polynomials with a definition region:  $[-\infty, +\infty]$

- B This switch controls the kind of regressor used in the fit
- 0 Regressors are products of standard polynomials (see preceding switch)
  - 1 Regressors are products of user-defined elementary functions. The user should write a `DOUBLE PRECISION` function `HELEFT(IEF, X)` where `IEF` is the elementary function code in the sense explained above: 10 times the function code plus 1. The function code number can vary from 1 to `PNEF`, number of user supplied elementary functions. `PNEF` has to be specified by the user **before** calling `HPARAM`, via a call to the routine `HSETPR` described below. The second parameter `X` is the point where the function should be calculated.
  - 2 Regressors are user-defined, in this case the variable `PMBF`, number of basic functions, must be set by the user via a call to `HSETPR` (see below). User regressors values are to be returned by the user-supplied `DOUBLE PRECISION` function `HBASFT(IBF, X)` where `IBF` is the user-defined regressor code in the sense explained above: 10 times the regressor code plus 2. The regressor code number can vary from 1 to `PMBF`, number of basic functions used for the parametrization. `PMBF` has to be specified by the user **before** calling `HPARAM`, via a call to the routine `HSETPR` described below, in the case that the switches B or C of the control parameter `IC` have the value 2. The parameter `X` is an array of length `NDIM` defining the coordinate where the regressor should be calculated.
- C This switch controls the selection of the regressors
- 0 Regressors are selected by the system. The parameter `PSEL` and the array `MAXPOW` help the user in controlling the total degree of each regressor (see below).
  - 1 for each elementary function or for each regressor, the logical function `HSELBF(ELEF)` gets called once before the beginning of the actual fitting procedure to set up the table of available elementary functions or regressors. `IELEF` is the code of the regressor or of the function being tested for acceptance. A value of `.TRUE.` returned will cause the regressor/elementary function to be accepted. The default version of this function which is supplied in `HB00K` always returns the value `.TRUE.`, while the user may want to write his own version of this function to exclude some of the regressors or of the elementary functions (according to the value of the B switch he has selected).
  - 2 The input array `ITERM` contains a list of selected regressors or elementary functions according to the value of the switch B. The array has to be at least `NDIM*PMBF` words and the variable `PMBF`, maximum number of elementary functions or regressors, should have been set via a call to `HSETPR`. In the case of elementary functions, the element `ITERM(IDIM+(IBF-1)*NDIM)` is the function of the variable  $x_{IDIM}$  to be multiplied by the coefficient number `IBF`, given a maximum expected number of `PMBF` coefficients. This can be of course reduced by the fitting program under considerations of linear dependency, as stated above, returning only `NC0` coefficients, thus after the fit `ITERM` will identify which regressors were actually used. In the case of user-defined regressors, only the first `PMBF` position of the `ITERM` array need to be filled, and the array will contain directly the code of the selected user-defined regressors.
- R This switch controls the system selection mechanism for the regressors:
- 0 Stepwise regression, the regression is calculated as explained before, and selected regressors may be eliminated in a further step of the procedure
  - 1 Forward regression. The backward stage is suppressed: a regressor included at one time will always remain in the regression later on
  - 2 Fixed-term regression: all selected regressors will appear in the final expression

- N This switch controls the normalization of the X range during the computation.
- 0 No normalization of X-range
  - 1 X scaled in the range  $[-1, 1]$
  - 2 X scaled in the range  $[0, 1]$
  - 3 X scaled in the range  $[0, +\infty]$

The value of R2MIN is used to determine the satisfactory end of the fitting process. If  $0 < R2MIN < 1$ , this value will be compared to the current sum of the squares of the residuals to determine whether the fit should be stopped or continued. If  $R2MIN \geq 1$ , the fitting process will be halted when the residual variance is minimal.

Various parameters which are relevant for the parametrization can be set via the routine HSETPR.

```
CALL HSETPR (CHNAME, VALUE)
```

### Input parameters:

CHNAME Name of the parameter to be set (of type CHARACTER)

VALUE Value assigned to parameter CHNAME (of type REAL)

Possible values for CHNAME are:

- 'PNEF' This parameter specifies to the system the number of elementary functions that are supplied by the user, in case the switch B of the IC parameter is set to 1. The system will build PNEF basic regressors made up by products of NDIM elementary functions, possibly user selected, as specified by the switch C of the parameter IC.
- 'PNBF' This parameter must be specified in case user regressors are used (B switch of IC set to 2), or in case the ITERM contains on input the selected regressors or basic elementary functions (C switch of IC parameter set to 2). The parameter is ignored in the other cases. This is the total number of user-defined regressors or elementary functions which the system will use for the parametrization process. Please note that in case of user given regressors, if the C switch of the IC parameter is either 0 or 1, the logical function HSELBF (ELEF) will always be called in order to verify the inclusion of the regressor IELEF in the list for the current fitting operation.
- 'PSEL' This parameter is used only in case of system-supplied elementary functions. It is the maximum limit for the sum of the terms  $POW(I) / MAXPOW(I)$  in each regressor, where  $POW(I)$  is the power of the system-supplied elementary function for the  $I^{th}$  variable ( $1 \leq I < NDIM$ ) and  $MAXPOW(I)$  is the user supplied maximum value for the degree of the system-supplied elementary functions for the  $I^{th}$  variable. This value must be  $0 < VALUE < NDIM$ . Note that setting PSEL to 0 selects the constant term for all the regressors. Setting PSEL to a value  $\geq NDIM$  has the effect of removing any limitation on the total degree of the regressors, leaving  $MAXPOW(I)$  as the only effective limitation on the degree of the elementary functions. This means that the total degree of the regressors can be equal to the sum of the NDIM elements of  $MAXPOW(I)$ . The system supplied default is 1.
- 'PFLV' This parameter determines the F-test significance level for rejection of already included regressors; by default it is set to 1. A higher value makes it more difficult for regressors to remain in the regression. The value of PFLV has to be  $> 0$ .



- 'PLUN' This parameter indicates the logical unit for writing the Fortran code of the function `FPARAM(X)`, which gives the value of the parametrization at point `X`. This Fortran code can be compiled and used in subsequent jobs. By default no code is written.
- 'PNBX' Maximum number of regressors that may be entered as input to the fitting process (after selection). By default `PNBX` is set to 500; setting `PNBX` to an appropriate value will avoid wasting space in dynamic area `/PAWC/`. This parameter may be set to the same value of `PNBF` or `PNEF` whichever is appropriate to save space.
- 'PNCX' Maximum number of regressors that may appear in the final expression of the parametrization (this number has to be  $\leq 50$ ). Default setting is 50. The same remark applies as for `PNBX`.

## Distributions

```
CALL HPARMN (X,Y,EY, NP, NVAR, IC, R2MIN, MAXPOW, COEFF*, ITERM*, NCO*)
```

### Input parameters:

<code>X</code>	Coordinates of data points (array of size <code>NP*NVAR</code> )
<code>Y</code>	Data to fit (array of length <code>NP</code> )
<code>EY</code>	Errors on data (array of length <code>NP</code> )
<code>NP</code>	Number of points to fit
<code>NVAR</code>	Dimension of <code>X</code> -space
<code>MAXPOW</code>	see <code>HPARAM</code>
<code>IC</code>	see <code>HPARAM</code>
<code>R2MIN</code>	see <code>HPARAM</code>

### Output parameters:

See `HPARAM`. The only difference concerns option `W` of `IC`, where:

- `W = 0` errors are taken from `EY`
- `W = 1` errors are set to 1

## 7.5 Smoothing

Histogramming is the least expensive and most popular density estimator, but has several statistical drawbacks. To name only two, it fails to identify structures that are much narrower than the bin size, and exhibits sharp discontinuities (statistical fluctuations) among adjacent low population bins.

The first problem is usually solved by adapting the bin width to the experimental resolution, or by re-binning after looking at the histogram. To filter out the statistical fluctuations, smoothing algorithms can be applied.

Three such techniques are implemented in `HBOOK`, the so called **353QH** (`HSM00F`), the method of **B-splines** (`HSPLI1`, `HSPLI2`, `HSPFUN`), and multiquadric smoothing (`HQUAD`). Before trying them out references [13, 14, 15, 16], and [16] should be consulted, and results taken with care.

```
CALL HSMOOF (ID, ICASE, CHI2*)
```

**Action:** Routine to smooth a 1-dimensional histogram according to algorithm 353QH, TWICE (see [13]).

**Input parameters:**

ID Histogram identifier  
 ICASE 0 and 1 replace original histogram by smoothed version;  
 2 superimposes as a function when editing.

**Output Parameter:**

CHI2 chisquare  $\chi^2$  between original and smoothed histogram.

**Remark:**

- The mean value and standard deviation are recalculated if ICASE=1
- The routine can be called several times for the same histogram identifier ID, for ICASE=1 or 2.

```
CALL HSPLI1 (ID, IC, N, K, CHI2*)
```

**Action:** B-splines smoothing of a 1-dimensional histogram.

**Input parameters:**

ID Identifier of an existing 1-dimensional histogram  
 IC Superimposition flag (IC=0 is identical to IC=1)  
 1 Replaces original contents by the value of the spline;  
 2 Superimposes the spline function when editing.  
 N Number of knots (when  $N \leq 0$  then  $N=13$ ).  
 K Degree of the splines (when  $K \geq 3$  then  $K=3$ ).

**Output Parameter:**

CHI2 chisquare  $\chi^2$  between original and smoothed histogram.

**Remarks:**

- HSPLI1 can be called several times for the same histogram identifier ID, for any value of the parameters
- If the distribution to be smoothed exhibits NP statistically relevant peaks then a rule of thumb to define the number of knots is,  $N = 4*NP+6$  for a spline of degree 3.

```
CALL HSPLI2 (ID,NX,NY,KX,KY)
```

**Action:** B-splines smoothing of a 2-dimensional histogram.

**Input parameters:**

ID Identifier of an existing 2-dimensional  
 NX Number of knots in the X interval (when  $NX \leq 0$  then  $NX=13$ ).  
 NY Number of knots in the Y interval (when  $NY \leq 0$  then  $NY=13$ ).  
 KX Degree of the spline in X (when  $KX \geq 3$  then  $KX=3$ ).  
 KY Degree of the spline in Y (when  $KY \geq 3$  then  $KY=3$ ).

**Remark:**

- The original contents of the histogram are replaced by the value of the spline approximation.
- See the remark about the number of knots for routine HSPLI1.

```
S = HSPFUN (ID,X,N,K)
```

**Action:** Performs a B-spline smoothing of a 1-dimensional histogram and returns the value at a given abscissa point.

**Input parameters:**

ID Identifier of an existing 1-dimensional histogram  
 X Abscissa  
 N Number of knots (when  $N \leq 0$  then  $N=13$ ).  
 K Degree of the splines (when  $K \geq 3$  then  $K=3$ ).

```
CALL HQUAD (ID,CHOPT,MODE,SENSIT,SMOOTH,NSIG*,CHISQ*,NDF*,FMIN*,FMAX*,
            IERR*)
```

**Action:** This routine fits multiquadric radial basis functions to the bin contents of a histogram or the event density of an Ntuple. (For Ntuples this is currently limited to “simple” ones, i.e., with 1, 2 or 3 variables; all events are used – no selection mechanism is implemented. Thus the recommended practice at the moment is to create a “simple” Ntuple and fill it from your “master” Ntuple with the NTUPLE/LOOP command and an appropriate SELECT.FOR function.) Routine HQUAD is called automatically in paw by the existing command SMOOTH. For a complete description of the method see reference [16].

**Input parameters:**

ID Histogram or Ntuple ID.  
 CHOPT Character variable containing option characters:  
 0 Replace original histogram by smoothed.

- 2 Do not replace original histogram but store values of smoothed function and its parameters. (The fitted function is regenerated from the values or the parameters with the FUNC option in HISTOGRAM/PLOT for histograms or with NTUPLE/DRAW for Ntuples.)

V Verbose.

MODE Mode of operation

0 Same as MODE = 3 (see below).

3 find significant points and perform unconstrained fit. If the histogram or Ntuple is unweighted perform a Poisson likelihood fit, otherwise a least squares fit (see MODE = 4).

4 force an unconstrained least squares fit in all cases. (This is a linear least squares problem and therefore the most efficient possible since it allows a single step calculation of the best fit and covariances. But note it assumes gaussian errors, even for low statistics, including the error on zero being 1.)

SENSIT Sensitivity parameter. It controls the sensitivity to statistical fluctuations (see Remarks).

SENSIT = 0. is equivalent to SENSIT = 1.

SMOOTH Smoothness parameter. It controls the (radius of) curvature of the multiquadric basis functions.

SMOOTH = 0. is equivalent to SMOOTH = 1.

### Output parameters:

NSIG no. of significant points or centres found, i.e., no. of basis functions used.

CHISQ chi-squared (see Remarks).

NDF no. of degrees of freedom.

FMIN minimum function value.

FMAX maximum function value.

IERR error flag, 0 if all's OK. (Hopefully helpful error messages are printed where possible.)

### Remarks:

- Empty bins are taken into account. (Poisson statistics are used for the unweighted case.)
- The multiquadric basis functions are  $\sqrt{r^2 + \Delta^2}$ , where  $r$  is the radial distance from its “centre”, and  $\Delta$  is a scale parameter and also the curvature at the “centre”. “Centres”, also referred to as “significant points”, are located at points where the 2nd differential or Laplacian of event density is statistically significant.
- The data must be statistically independent, i.e., events (weighted or unweighted) drawn randomly from a parent probability distribution or differential cross-section, e.g., you cannot further smooth a previously smoothed distribution.
- For histograms, the chi-squared (CHISQ) is that of the fit to the original histogram assuming gaussian errors on the original histogram even for low statistics, including the error on zero being 1. It is calculated like this even for a Poisson likelihood fit; in that case the maximum likelihood may not correspond to the minimum chi-squared, but CHISQ can still be used, with NDF (the no. of degrees of freedom), as a goodness-of-fit estimator. For Ntuples, an internally generated and temporary histogram is used to calculate CHISQ in the same way.

## 7.6 Random Number Generation

```
R = HRNDM1 (ID)
```

**Action:** Returns a random number distributed according to the contents of 1-dimensional histogram.

**Input parameter:**

ID Identifier of an existing 1-dimensional histogram according to whose distribution random numbers have to be generated.

**Remark:**

- The first time HRNDM1 is called on a given histogram with identifier ID, the channel contents of the original histogram are replaced by the integrated channel contents, normalized to 1.
- The histogram ID must be booked with 1 bin/word (VMX=0)
- If the histogram ID does not exist, zero is returned
- If the histogram ID is empty, or if the sum of its channel contents is not positive, a message is printed and a flat distribution is assumed.

```
CALL HRNDM2 (ID, RX*, RY*)
```

**Action:** Returns a random point (RX, RY) distributed according to the contents of a 2-dimensional histogram.

**Input parameter:**

ID Identifier of a 2-dimensional histogram

**Output parameters**

RX, RY Random numbers.

**Remark:**

- Same as HRNDM1
- These 2 entries can be used in conjunction with HBFUN1 and HBFUN2 respectively.

## 7.7 Fitting with finite Monte Carlo statistics

Most of the following text is taken from [17] - see this publication for more discussion and details of the algorithm, and examples.

Analysis of results from HEP experiments often involves estimation of the composition of a sample of data, based on Monte Carlo simulations of the various sources. Data values (generally of more than one dimension) are binned, and because the numbers of data points in many bins are small, a  $\chi^2$  minimisation is inappropriate, so a maximum likelihood technique using Poisson statistics is often used. This package incorporates the fact that the Monte Carlo statistics used are finite and thus subject to statistical fluctuations.

### The Problem.

A common problem arises in the analysis of experimental data. There is a sample of real data, each member of which consists of a set of values  $\{x_r\}$  – for example, a set of  $Z$  decay events with inclusive leptons, for each of which there is a value of  $\{p^\ell, p_t^\ell, T, E_{vis}\}$ , or a set of measured particle tracks, each with  $\{p, \frac{dE}{dx}, \cos \theta\}$ . You know that these arise from a number of sources: the lepton events from direct  $b$  decays, cascade  $b$  decays,  $c$  decays, and background, the tracks from  $\pi$ ,  $K$ , and  $p$  hadrons. You wish to determine the proportions  $P_j$  of the different sources in the data.

There is no analytic form available for the distributions of these sources as functions of the  $\{x_r\}$ , only samples of data generated by Monte Carlo simulation. You therefore have to bin the data, dividing the multidimensional space spanned by the  $\{x_r\}$  values into  $n$  bins. This gives a set of numbers  $\{d_1, d_2, \dots, d_n\}$ , where  $d_i$  is the number of events in the real data that fall into bin  $i$ . Let  $f_i(P_1, P_2, \dots, P_m)$  be the predicted number of events in the bin, given by the strengths  $P_j$  and the numbers of Monte Carlo events  $a_{ji}$  from source  $j$  in bin  $i$ .

$$f_i = N_D \sum_{j=1}^m P_j a_{ji} / N_j \quad (7.1)$$

where  $N_D$  is the total number in the data sample, and  $N_j$  the total number in the MC sample for source  $j$ .

$$N_D = \sum_{i=1}^n d_i \quad N_j = \sum_{i=1}^n a_{ji} \quad (7.2)$$

The  $P_j$  are then the actual proportions and should sum to unity. It is convenient to incorporate these normalisation factors into the strength factors, writing  $p_j = N_D P_j / N_j$ , giving the equivalent form

$$f_i = \sum_{j=1}^m p_j a_{ji} \quad (7.3)$$

One approach is then to estimate the  $p_j$  by adjusting them to minimise

$$\chi^2 = \sum_i \frac{(d_i - f_i)^2}{d_i} \quad (7.4)$$

This  $\chi^2$  assumes that the distribution for  $d_i$  is Gaussian; it is of course Poisson, but the Gaussian is a good approximation to the Poisson at large numbers.

Unfortunately it often happens that many of the  $d_i$  are small, in this case one can go back to the original Poisson distribution, and write down the probability for observing a particular  $d_i$  as

$$e^{-f_i} \frac{f_i^{d_i}}{d_i!} \quad (7.5)$$

and the estimates of the proportions  $p_j$  are found by maximising the total likelihood or, for convenience, its logarithm (remembering  $a^b = e^{b \ln a}$ , and omitting the constant factorials)

$$\ln \mathcal{L} = \sum_{i=1}^n d_i \ln f_i - f_i \quad (7.6)$$

This accounts correctly for the small numbers of data events in the bins, and is a technique in general use. It is often referred to as a ‘‘binned maximum likelihood’’ fit.

But this does not account for the fact that the Monte Carlo samples used may also be of finite size, leading to statistical fluctuations in the  $a_{ji}$ . In Equation 7.1 it can be seen that these are damped by a factor  $N_D/N_j$ , but we cannot hope that this is small.

So: disagreements between a particular  $d_i$  and  $f_i$  arise from incorrect  $p_j$ , from fluctuations in  $d_i$ , and from fluctuations in the  $a_{ji}$ . Binned maximum likelihood reckons with the first two sources, but not the third. In the  $\chi^2$  formalism of Equation 7.4 this can be dealt with by adjusting the error used in the denominator

$$\chi^2 = \sum_i \frac{(d_i - f_i)^2}{d_i + N_D^2 \sum_j a_{ji}/N_j^2} \quad (7.7)$$

but this still suffers from the incorrect Gaussian approximation. The problem is to find the equivalent treatment for the binned maximum likelihood method.

### Methodology.

The correct way to view the problem is as follows. For each source, in each bin, there is some (unknown) expected number of events  $A_{ji}$ . The prediction for the number of data events in a bin is not Equation 7.3 but

$$f_i = \sum_{j=1}^m p_j A_{ji} \quad (7.8)$$

From each  $A_{ji}$  the corresponding  $a_{ji}$  is generated by a distribution which is in fact binomial, but can be taken as Poisson if  $A_{ji} \ll N_j$  (which is indeed the case, as our problem is just that a large number of total events gives a small number in each bin.)

The total likelihood which is to be maximised is now the combined probability of the observed  $\{d_i\}$  and the observed  $\{a_{ji}\}$  and we want to maximise

$$\ln \mathcal{L} = \sum_{i=1}^n d_i \ln f_i - f_i + \sum_{i=1}^n \sum_{j=1}^m a_{ji} \ln A_{ji} - A_{ji} \quad (7.9)$$

The estimates for the  $p_j$  (which we want to know) and the  $A_{ji}$  (in which we're not really interested) are found by maximising this likelihood. This is the correct methodology to incorporate the MC statistics: unfortunately it consists of a maximisation problem in  $m \times (n + 1)$  unknowns. However, the problem can be made much more amenable.

### The Solution.

To find the maximum we differentiate Equation 7.9 (including Equation 7.8 for  $f_i$ ) and set the derivatives to zero. This gives two sets of equations, those for the differentials with respect to  $p_j$

$$\sum_{i=1}^n \frac{d_i A_{ji}}{f_i} - A_{ji} = 0 \quad \forall j \quad (7.10)$$

and those for the differentials with respect to  $A_{ji}$

$$\frac{d_i p_j}{f_i} - p_j + \frac{a_{ji}}{A_{ji}} - 1 = 0 \quad \forall i, j \quad (7.11)$$

These  $m \times (n+1)$  simultaneous equations are nonlinear and coupled (remembering that the  $f_i$  that appear in them are functions of the  $p_j$  and the  $A_{ji}$ ). However they can be remarkably simplified. Equations 7.11 can be rewritten

$$1 - \frac{d_i}{f_i} = \frac{1}{p_j} \left( \frac{a_{ji}}{A_{ji}} - 1 \right) \quad \forall i, j \quad (7.12)$$

The left hand side depends on  $i$  only, so write it as  $t_i$ .

$$t_i = 1 - \frac{d_i}{f_i} \quad (7.13)$$

The right hand side then becomes

$$A_{ji} = \frac{a_{ji}}{1 + p_j t_i} \quad (7.14)$$

which is a great simplification: for a given set of  $p_j$ , the  $n \times m$  unknown quantities  $A_{ji}$  are given by the  $n$  unknown quantities  $t_i$ .

The  $t_i$  are given by Equation 7.13. If  $d_i$  is zero then  $t_i$  is 1: if not then

$$\frac{d_i}{1 - t_i} = f_i = \sum_j p_j A_{ji} = \sum_j \frac{p_j a_{ji}}{1 + p_j t_i} \quad (7.15)$$

If these  $n$  equations are satisfied, with Equation 7.14 used to define the  $A_{ji}$ , then all the  $m \times n$  Equations 7.11 are satisfied.

The method adopted by HMCLNL is (for a given set of  $p_j$ ), to solve equations 7.15 for the  $t_i$ , thus giving the  $A_{ji}$  via equation 7.14. The log likelihood may then be calculated using equation 7.9. The maximum of the likelihood may then be found using numerical means - HMCMLL uses MINUIT to perform this maximisation (this is equivalent to solving equations 7.10).

Although there are  $n$  equations 7.15, to be solved numerically, this does not present a problem. They are not coupled, and each equation clearly has one and only one solution in the ‘allowed’ region for  $t_i$ , i.e. the region where the  $A_{ji}$  are all positive, which lies between  $t = -1/p_{max}$  and  $t = 1$  ( $p_{max}$  being the largest of the  $p_j$ ).  $t = 0$  is a suitable place to start, and Newton’s method readily gives a solution. Special considerations apply when there are no events from one or more of the MC sources - more details of the solution can be found in [17].

### Other points concerning the solution

Some nice points emerge from the algebra. The Equations 7.10 can be written more simply as

$$\sum_{i=1}^n t_i A_{ji} = 0 \quad \forall j \quad (7.16)$$

Also one can replace  $\frac{d_i}{f_i}$  by  $1 + (A_{ji} - a_{ji})/p_j A_{ji}$ , from Equation 7.12, and the equations then reduce to

$$\sum_i A_{ji} = \sum_i a_{ji} \quad \forall j \quad (7.17)$$

These are telling us that the estimates of the  $A_{ji}$  for some source will change the shape of the distribution from that of the MC data  $a_{ji}$ , but will not change the overall total number.



Equation 7.11 can be multiplied by  $A_{ji}$  and summed over  $j$  to give

$$\sum_j d_i - p_j A_{ji} + a_{ji} - A_{ji} = 0$$

summing over  $i$ , and using Equation 7.17, gives

$$\begin{aligned} \sum_i d_i &= \sum_i \sum_j p_j a_{ji} \\ N_D &= \sum_j p_j N_j \end{aligned} \quad (7.18)$$

which nicely returns the normalisation, and makes clear the significance of the  $p_j$ . It is interesting that such an automatic normalisation does not occur in the  $\chi^2$  minimisation technique of Equation 7.4. If the different  $p_j$  are allowed to float independently they return a set of values for which the fitted number of events is generally less than the actual total number, as downward fluctuations have a smaller assigned error and are given higher weight.

### Weighted Events

In some problems it is necessary to apply weights to the Monte Carlo data before comparing it with the real data.

An example occurs when events are detected with some efficiency, which differs from bin to bin, and the form of which is known exactly. Rather than reject MC events on a random basis, it is more effective to include them all, weighted by the appropriate efficiency.

Another such instance arises if MC data has been generated according to one function, but another one is desired. For example, data on  $\{p, \frac{dE}{dx}, \cos \theta\}$  may have been generated using some form of the Bethe-Bloch Equation

$$\frac{dE}{dx} = F_0(p, \theta, m_j)$$

and with hindsight it is realised that some other form  $F_1(p, \theta, m_j)$  is more correct. This can be accommodated by weighting each bin by

$$w_{ji} = F_1 / F_0$$

In such a case the predicted number of events in each bin is modified and Equation 7.8 becomes

$$f_i = \sum_{j=1}^m p_j w_{ji} A_{ji} \quad (7.19)$$

The likelihood function of Equation 7.9 is unchanged. The differentials of Equation 7.10 become

$$\sum_{i=1}^n \left( \frac{d_i}{f_i} - 1 \right) w_{ji} A_{ji} = 0 \quad \forall j \quad (7.20)$$

and the differentials with respect to the  $A_{ji}$  give the equivalents of Equations 7.14 and 7.15.

$$A_{ji} = \frac{a_{ji}}{1 + p_j w_{ji} t_i} \quad (7.21)$$

$$\frac{d_i}{1 - t_i} = f_i = \sum_j \frac{p_j w_{ji} a_{ji}}{1 + p_j w_{ji} t_i} \quad (7.22)$$

The solution of these 4 sets of equations proceeds as before. Notice that, as one would expect, if  $w_{ji}$  is the same for all  $i$ , then this merely amounts to a scaling of the Monte Carlo strength  $p_j$ .

So far this assumes that the weight is the same for all events from a given source in a given bin: the quantity  $w_{ji}$ . This may not be the case if either (a) the bin size is so large that the weight factor varies significantly within the bin or (b) the weight factor depends not only on the variable(s)  $x$  used in making the comparison but also on some other variable(s) – call it  $z$  – which is not binned and used in the comparison; perhaps it does not exist in the real data. In either case the weights of different events from the same source in the same bin can be different.

In such a case the Equations 7.19 – 7.22 still apply, with  $w_{ji}$  equal to the ideal average weight for source  $j$  in bin  $i$ . This may be a known quantity: more likely it has to be estimated using the actual weights attached to the MC data values themselves.

At this point one has to worry whether the discrepancy between the average actual weight and the true average weight should be included in the fitting procedure, estimation and errors. Now in practice this method of weighting only works satisfactorily if the weights do not differ very much. The variance of a sum of weights from Poisson sources is  $\sum_i w_i^2$  [18] and thus the proportional error on the bin contents  $\sqrt{\sum_i w_i^2} / \sum_i w_i$  is greater than the  $1/\sqrt{N}$  obtained from unweighted Poisson statistics, and this effect get worse as the spread of weights,  $\overline{w^2} - \bar{w}^2$ , gets larger. Fluctuations in a small number of events with large weights will swamp the information obtained from low weight events. Thus in any application the spread in weights for a source in a bin should be small, and this means that the resulting uncertainty in its value will also be small.

Some insight can be gained by noting that in the set of Equations 7.19 – 7.22 the weights  $w_{ji}$  always appear together with the  $p_j$ . (Equation 7.20 can be multiplied by  $p_j$  to make this explicit). Thus if the weights are all too high by some factor the strengths will be low by exactly the same factor. So the error in the  $p_j$  estimates resulting from uncertainties in the weights is of the same order as that uncertainty, and in any application this should be small.

In HMCINI, the weight distributions provided are normalised so that

$$\sum_i w_{ji} a_{ji} = \sum_i a_{ji} = N_j$$

and the normalisation factors (These should always be 1 unless there is an **efficiency** component to the distribution) are preserved. Inclusion of weights is then regarded as a two stage problem.

1. The fitting of the reweighted Monte Carlo distributions to the data distribution, in which the Monte Carlo normalisation is preserved, to find a set of fractions  $P_{j'l}$ . These correspond to the fractions of each source actually present in the data sample you provide.
2. The transformation of the  $P_{j'l}$  into the  $P_j$ , the fractions of each source which were present in the data sample **before the efficiencies were applied to the data**.

This is implemented as follows. The user (or HMCMLL) calls HMCLNL with the  $P_{j'l}$ . These are transformed into the  $P_j$  within HMCLNL using the normalisation factors  $\alpha_j$  calculated by HMCINI.

$$P_j = \frac{\sum_j P_{j'l}}{\sum_j \alpha_j P_{j'l}} \times \alpha_j P_{j'l}$$

where

$$\alpha_j = \frac{\sum_i w_{ji} a_{ji}}{N_j}$$

and HMCLNL calculates the correct log-likelihood using the  $P_j!$  and the normalised weight distributions.

### HBOOK routines

The following three routines are intended to help with problems of the above type. Subroutine HMCMLL uses `minuit` to perform the log-likelihood maximisation and return a set of fractions. Functions HMCINI and HMCLNL are provided for those who wish to perform the fit themselves.

N.B. Real parameters and functions are all REAL\*8 (Double precision on most machines).

```
CALL HMCMLL (IDD, IDM, IDW, NSRC, CHOPT, IFIX, FRAC, FLIM, START,
            STEP, UP, PAR*, DPAR*)
```

**Action:** Fits the given Monte Carlo distributions to the data distribution, using a binned maximum likelihood fit which includes the effect of both data and Monte Carlo statistics, and allows weights to be provided for each Monte Carlo distribution. The data, Monte Carlo and weight distributions must be presented in identically binned 1 dimensional histograms. Weight distributions which just change the shape of the Monte Carlo spectra (i.e. *not* efficiency distributions) must be normalised so that

$$\sum_i w_{ji} a_{ji} = \sum_i a_{ji} = N_j.$$

The best estimate of the fraction of each Monte Carlo distribution present in the data distribution is returned, with an error estimate where required.

#### Input parameters:

- IDD     Data histogram identifier.
- IDM     Array of dimension NSRC containing Monte Carlo histogram identifiers.
- IDW     Array of dimension NSRC containing weight histogram identifiers. ('W' option only).
- NSRC    Number of Monte Carlo sources. Must be greater than 1.
- CHOPT 'F'     Fix one or more of the fractions. Default is for all fractions to vary freely.
- 'L'     Set limits on the fractions as given in FLIM. Default is no limits.
- 'W'     Use the weight histograms provided. For non existent weight histograms, and if the 'W' option is not requested, a dummy weight histogram in which all entries are 1 is booked.
- 'S'     Scan the likelihood function with respect to each fit parameter, before and after the fit. If the 'N' option is specified, the function will only be scanned once for each parameter.
- 'N'     Do not perform the fit.
- 'P'     Use the parameter start points and initial step sizes provided in START and STEP. If the 'P' option is not specified then the start point for each free parameter is

$$\frac{1 - \Sigma_f}{NSRC - N_f}$$

, where  $\Sigma_f$  is the sum of the fixed fractions, and  $N_f$  is the number of fixed fractions; and the initial step size is 0.01.

'E'	Perform a detailed error analysis using the MINUIT routines HESSE and MINOS.
IFIX	Array of dimension NSRC containing '1' if a parameter is to be fixed in the fit, '0' otherwise. ('F' option only).
FRAC	Array of dimension NSRC with the values at which parameters are to be fixed. ('F' option only).
FLIM	Array of dimension (NSRC, 2) with the lower, then upper limits on the parameters. ('L' option only.)
START	Array of dimension NSRC with the start values for each parameter. ('P' option only - if 'P' option is chosen then default start values are used if values in START are negative).
STEP	Array of dimension NSRC with initial step values for each parameter. ('P' option only - if 'P' option is chosen then default step values are used if values in STEP are negative).
UP	UP value for the error estimate ('E' option only). Default 0.5 (if user supplies negative or zero value for UP when 'E' option is chosen). See the Minuit manual for definition of UP.

**Output parameters:**

PAR	Array of dimension NSRC with the final fitted values of the parameters.
DPAR	Array of dimension NSRC with the errors on the final fitted values of the parameters.

```
CALL HMCINI (IDDATA, IDMC, IDWT, NSRC, CHOPT, IERR)
```

**Action:** Initialisation routine for function HMCLNL, needs to be called each time a new set of histograms is introduced (generally once at the beginning of each fit). Performs some error checking and sets up a dummy weight histogram if necessary.

**Input parameters:**

IDDATA	Data histogram identifier.
IFIXMC	Array of dimension NSRC containing '1' if a
IDMC	Array of dimension NSRC containing Monte Carlo histogram identifiers.
IDWT	Array of dimension NSRC containing weight histogram identifiers. ('W' option only).
NSRC	Number of Monte Carlo sources.
CHOPT	'W' Use the weight histograms provided. For non existent weight histograms, and if the W option is not requested, a dummy weight histogram in which all entries are 1 is booked.
IERR	Error flag - set to 1 if the parameters sent to HMCINI were not usable (e.g. incompatibility between data and MC histograms, number of MC sources less than 2), 0 otherwise.

```
VARIAB = HMCLNL (FRAC)
```

**Action:** HMCLNL is a double precision function giving the log likelihood (including effect of both data and Monte Carlo statistics) that the data distribution arose from a distribution given by combining the Monte Carlo distributions, weighted by the weights provided, using the fractions given in FRAC. HMCINI must be called before this function may be used.

**Input parameters:**

FRAC	Array of dimension NSRC containing the fraction of each Monte Carlo distribution you wish to assume is in the data distribution, in order to calculate the log likelihood.
------	--

---

**Example of use of HMCMLL**

---

```

PROGRAM MCSTAT

PARAMETER (NPAWC=10000)
COMMON/PAWC/H(NPAWC)

INTEGER NMCSRC
PARAMETER (NMCSRC=2)

* declarations for HMCMLL
  INTEGER IDDATA, IDMC(NMCSRC), IDWT(NMCSRC), IFIXMC(NMCSRC)
  DOUBLE PRECISION FLIM(NMCSRC,2), FSTART(NMCSRC),
+ FSTEP(NMCSRC), FUP, FRAC(NMCSRC), ANS(NMCSRC), DANS(NMCSRC)

  DATA IDDATA, IDMC, IDWT/10,1301,1302,1351,1352/

  CALL HLIMIT(NPAWC)

* Set 'UP' to correspond to 70% confidence level for 2 parameter fit.
  FUP=1.2

* Read in your data, Monte Carlo and Weight histograms
  CALL HRGET(10, 'HMCHIS.PAW', ' ')
  DO 20 JSRC=1, NMCSRC
    CALL HRGET(IDMC(JSRC), 'HMCHIS.PAW', ' ')
    CALL HRGET(IDWT(JSRC), 'HMCHIS.PAW', ' ')
20  CONTINUE

* perform log likelihood maximisation and error analysis,
* using user weights + setting limits on the fractions.
  WRITE(6,1000)
1000  FORMAT(' ** Fit with error analysis - use user weights
+and limits',/)
  FLIM(1,1)=0.0
  FLIM(2,1)=1.0D0
  FLIM(1,2)=0.0
  FLIM(2,2)=1.0D0
  CALL HMCMLL(IDDATA, IDMC, IDWT, NMCSRC, 'EWL', IFIXMC,
+ FRAC, FLIM, FSTART, FSTEP, FUP, ANS, DANS)

  END

```

---

The program fits the first two histograms shown (1302 is dotted) to the second. The weights for the first distribution are all 1, for the second they are all 0.8.

---

**Output Generated**

---

```

** Fit with error analysis - use user weights and limits

MINUIT RELEASE 93.08  INITIALIZED.  DIMENSIONS 100/ 50  EPSMAC= 0.56E-16
MCMLL: You have 2 free fractions and 0 fixed

PARAMETER DEFINITIONS:

```

NO.	NAME	VALUE	STEP SIZE	LIMITS
1	'P1	0.50000	0.10000E-01	0.00000E+00 1.0000
2	'P2	0.50000	0.10000E-01	0.00000E+00 1.0000

```

*****
** 1 **CALL FCN 1.000
*****
*****
** 2 **SET ERR 0.5000
*****
*****
** 3 **MIGRAD
*****

FIRST CALL TO USER FUNCTION AT NEW START POINT, WITH IFLAG=4.
START MIGRAD MINIMIZATION. STRATEGY 1. CONVERGENCE WHEN EDM .LT. 0.50E-04

FCN= -8317.393 FROM MIGRAD STATUS=INITIATE 8 CALLS 10 TOTAL
EDM= unknown STRATEGY= 1 NO ERROR MATRIX

EXT PARAMETER CURRENT GUESS STEP FIRST
NO. NAME VALUE ERROR SIZE DERIVATIVE
1 P1 0.50000 0.10000E-01 0.20001E-01 -8.1370
2 P2 0.50000 0.10000E-01 0.20001E-01 8.7598
ERR DEF= 0.50

MIGRAD MINIMIZATION HAS CONVERGED.

MIGRAD WILL VERIFY CONVERGENCE AND ERROR MATRIX.
COVARIANCE MATRIX CALCULATED SUCCESSFULLY

FCN= -8319.763 FROM MIGRAD STATUS=CONVERGED 45 CALLS 47 TOTAL
EDM= 0.66E-08 STRATEGY= 1 ERROR MATRIX ACCURATE

EXT PARAMETER STEP FIRST
NO. NAME VALUE ERROR SIZE DERIVATIVE
1 P1 0.64665 0.75183E-01 0.25797E-02 -0.77581E-03
2 P2 0.35335 0.70935E-01 0.24335E-02 -0.10448E-02
ERR DEF= 0.50

EXTERNAL ERROR MATRIX. NDIM= 50 NPAR= 2 ERR DEF= 0.50
0.570E-02-0.460E-02
-0.460E-02 0.507E-02

PARAMETER CORRELATION COEFFICIENTS
NO. GLOBAL 1 2
1 0.85488 1.000-0.855
2 0.85488 -0.855 1.000
*****
** 4 **SET ERR 1.200
*****
MCMLL: SET UP VALUE TO 1.20
MCMLL: FOR 2 FREE PARAMETERS
*****
** 5 **MINOS
*****

MINUIT TASK: *** HBOOK New ll maximisation

FCN= -8319.763 FROM MINOS STATUS=SUCCESSFUL 72 CALLS 119 TOTAL
EDM= 0.66E-08 STRATEGY= 1 ERROR MATRIX ACCURATE

EXT PARAMETER PARABOLIC MINOS ERRORS
NO. NAME VALUE ERROR NEGATIVE POSITIVE
1 P1 0.64665 0.11579 -0.11144 0.12598
2 P2 0.35335 0.10932 -0.11560 0.10891
ERR DEF= 1.2

```

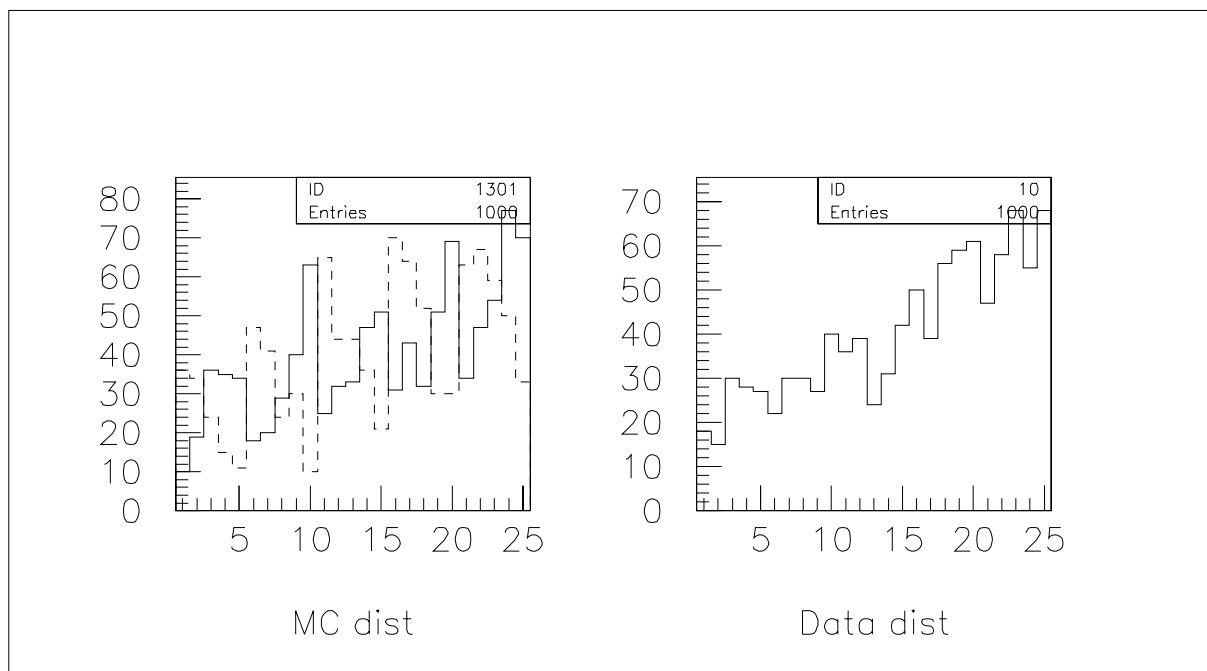

Figure 7.1: Monte Carlo distributions (left) and data distribution (right)

### 7.7.1 Example of fits

```

SUBROUTINE HEXAM5
*,=====>
*          OPERATIONS ON HISTOGRAMS AND FITTING
*..=====> (R.Brun, modified by M.Goossens)
COMMON/HFPAR/PAR(6)
COMMON/HFGAUS/AG,BG,CG
DOUBLE PRECISION AG,BG,CG
DIMENSION X(100),Y(100)
DIMENSION XF(4000,2),YF(4000),EY(4000),SIGPAR(6)
DOUBLE PRECISION COV(6,6)
EXTERNAL HFUNF,HFUNFV,HFUNGA
CHARACTER*12 TITL1
DATA TITL1/'TITLE OF ID1'/

*-----
*
*          GET hist 110 from data base
*
CALL HRGET(110,'hexam.dat',' ')
CALL HRGET(210,'hexam.dat',' ')
*
*
CALL HBOOK1(1,TITL1,100,0.,1.,0.)
CALL HCOPY(1,2,'TITLE OF ID = 2')
*
*          Gets information from ID=110 and fills new IDs 1,2
*

```

```

CALL HUNPAK(110,X,'HIST',1)
CALL UCOPY(X,Y,100)
CALL VZERO(X(51),50)
CALL HPAK(1,X)
CALL HPHIST(1,'HIST',1)
CALL VZERO(Y,50)
CALL HPAK(2,Y)
CALL HPHIST(2,'HIST',1)
*
*           adds 1 and 2. Identifier 3 is created and will contain
*           result of addition
*
CALL HOPERA(1,'+',2,3,1.,1.)
CALL HCOPY(3,4,' ')
*
*           Fits 3 with function HFUNF, similar to example 2 .
*           Initializes parameters. Prints results of the last
*           iteration.
*           Superimpose result of fit to the histogram
*           The result of this fit can be compared with the initial
*           parameters of example 2
*
PAR(1) = 40.
PAR(2) = 20.
PAR(3) = 0.4
PAR(4) = 0.6
PAR(5) = 0.1
PAR(6) = 0.1
*
CALL HFITH(3,HFUNF,'V',6,PAR(1),ST,PMI,PMA,SIGPAR,CHI2)
*
CALL HPHIST(3,'HIST',1)
*
*           Fits a two-dimensional distribution (xf,yf) with HFITN
*           initialize parameters. Prints results of the last
*           iteration.
*           Errors EY automatically computed as SQRT(yf)
*
NY=0
DO 10 J=1,40
  DO 5 I=1,100
    CONT=HIJ (210,I,J)
    IF (CONT.EQ.0.) GOTO 5
    NY=NY+1
    YF(NY)=CONT
    EY(NY)=SQRT(CONT)
    CALL HIJXY (210,I,J,X1,X2)
    XF(NY,1)=X1+0.005
    XF(NY,2)=X2+0.0125
  5  CONTINUE
10 CONTINUE
PAR(1) = 3.
PAR(2) = 1.
PAR(3) = 0.3
PAR(4) = 0.7
PAR(5) = 0.07

```



```

    PAR(6) = 0.12
*
    CALL HFITV (NY,NY,1,XF,YF,EY,HFUNFV,'V',6,PAR(1),ST,PMI,PMA,
+           SIGPAR,CHI2)
*   Get covariance matrix of last fit from Minuit.
*   Minuit parameters on 4-byte machines are Double precision
    CALL MNEMAT(COV,6)
    WRITE(31,*) ' COVARIANCE MATRIX'
    WRITE(31,*) ' *****'
    DO 20 I=1,6
        WRITE(31,'(6(D12.4,1X))') (COV(I,J),J=1,I)
20 CONTINUE
*
*   Gaussian fit. Prints first and last iterations.
*
    AG = 2.
    BG = 0.4
    CG = 0.1
    CALL HDELETE (0)
    CALL HBFUN1 (1,' ',100,0.,1.,HFUNGA)
    CALL HBOOK1 (5,' ',100,0.,1.,1000.)
    DO 30 I=1,5000
        XR=HRNDM1 (1)
        CALL HFILL (5,XR,0.,1.)
30 CONTINUE
*
    PAR(1) = 200.
    PAR(2) = 0.4
    PAR(3) = 0.1
    CALL HFITHN(5,'G',' ',3,PAR(1),ST,PMI,PMA,SIGPAR,CHI2)
    CALL HPRINT (5)
    CALL HDELETE (0)
*
    END
*
    FUNCTION HFUNF(X)
    COMMON/HFPAR/PAR(6)
    DOUBLE PRECISION A1,A2,C1,C2,XM1,XM2,XS1,XS2,X1,X2
*   Force double precision calculation
    C1 = PAR(1)
    C2 = PAR(2)
    XM1 = PAR(3)
    XM2 = PAR(4)
    XS1 = PAR(5)
    XS2 = PAR(6)
*
    A1=-0.5*((X-XM1)/XS1)**2
    A2=-0.5*((X-XM2)/XS2)**2
    IF(A1.LT.-20.) THEN
        X1=0.
    ELSEIF(A1.GT.20.) THEN
        X1=1.E5
    ELSE
        X1=C1*EXP(A1)
    ENDIF
    IF(A2.LT.-20.) THEN
        X2=0.

```





```

MINUIT RELEASE 90.10  INITIALIZED.  DIMENSIONS 100/ 50  EPSMAC=  0.89E-15
*****
**   1 **SET EPS  0.1000E-06
*****
FLOATING-POINT NUMBERS ASSUMED ACCURATE TO  0.100E-06

*****
*
* Function minimization by SUBROUTINE HFITH *
* Variable-metric method *
* ID =          3  CHOPT = V *
*
*****
Convergence when estimated distance to minimum (EDM) .LT.  0.10E-03

PARAMETER DEFINITIONS:
  NO.  NAME      VALUE      STEP SIZE      LIMITS
  1  'P1      '  40.000      12.000      no limits
  2  'P2      '  20.000      6.0000      no limits
  3  'P3      '  0.40000      0.12000      no limits
  4  'P4      '  0.60000      0.18000      no limits
  5  'P5      '  0.10000      0.30000E-01  no limits
  6  'P6      '  0.10000      0.30000E-01  no limits
*****
**   2 **SET PRINT  0.0000
*****
*****
**   3 **MIGRAD  1160.      1.000
*****

MIGRAD MINIMIZATION HAS CONVERGED.

MIGRAD WILL VERIFY CONVERGENCE AND ERROR MATRIX.

FCN=  81.55959      FROM MIGRAD  STATUS=CONVERGED  391 CALLS      392 TOTAL
                    EDM=  0.21E-05  STRATEGY= 1      ERROR MATRIX ACCURATE

EXT PARAMETER
NO.  NAME      VALUE      ERROR      STEP      FIRST
    P1      154.37      3.8591      0.97447      -0.16735E-03
    P2      74.934      2.1210      0.51925      0.16237E-03
    P3      0.30351      0.15347E-02  0.76783E-03  -0.91430
    P4      0.70017      0.29587E-02  0.17713E-02  0.19339
    P5      0.69299E-01  0.12334E-02  0.28758E-03  0.39057
    P6      0.11985      0.27357E-02  0.62656E-03  0.52392

CHISQUARE = 0.9164E+00  NPFIT =  95

```

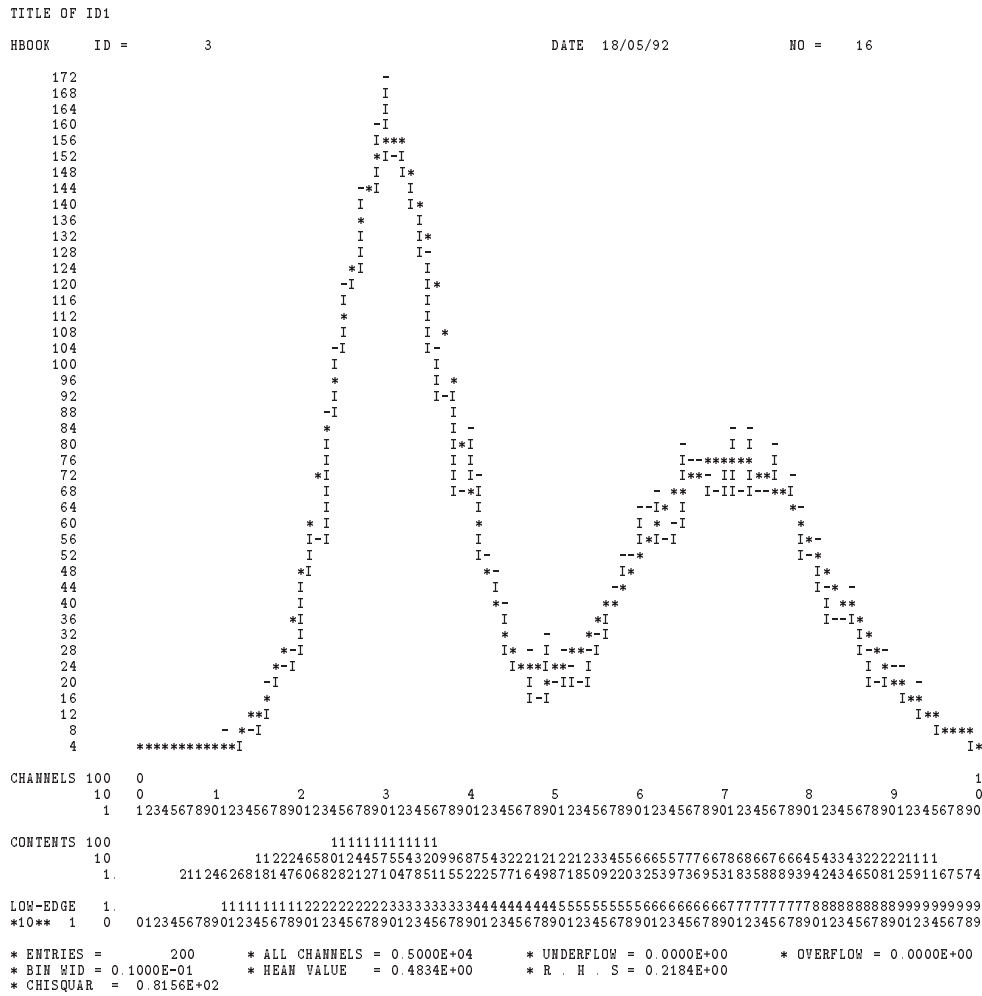

```

*****
*
* Function minimization by SUBROUTINE HFITV *
* Variable-metric method *
* ID =          0  CHOPT = V *
*
*****
Convergence when estimated distance to minimum (EDM) .LT.  0.10E-03

PARAMETER DEFINITIONS:
NO.  NAME      VALUE      STEP SIZE      LIMITS
 1 'P1      '    3.0000      0.90000      no limits
 2 'P2      '    1.0000      0.30000      no limits
 3 'P3      '    0.30000     0.90000E-01  no limits
 4 'P4      '    0.70000     0.21000      no limits
 5 'P5      '    0.70000E-01 0.21000E-01  no limits
 6 'P6      '    0.12000     0.36000E-01  no limits
*****
**   4 **SET PRINT  0.0000
*****
*****
**   5 **MIGRAD   1160.    1.000
*****
MACHINE ACCURACY LIMITS FURTHER IMPROVEMENT.

MIGRAD MINIMIZATION HAS CONVERGED.

MIGRAD WILL VERIFY CONVERGENCE AND ERROR MATRIX.
EIGENVALUES OF SECOND-DERIVATIVE MATRIX:
  -0.1596E+01 -0.6458E+00  0.3800E+00  0.7478E+00  0.1277E+01  0.5837E+01
MINUIT WARNING IN HESSE
===== MATRIX FORCED POS-DEF BY ADDING  1.6018      TO DIAGONAL.
MIGRAD TERMINATED WITHOUT CONVERGENCE.

FCN=  1709.709      FROM MIGRAD  STATUS=FAILED      197 CALLS      198 TOTAL
      EDM=  0.41E+02  STRATEGY= 1      ERR MATRIX NOT POS-DEF

EXT PARAMETER          APPROXIMATE          STEP          FIRST
NO.  NAME      VALUE      ERROR      SIZE      DERIVATIVE
 1    P1      2.4709      0.73263E-01  0.00000      4.1109
 2    P2      1.8247      0.37237E-01  0.00000      8.5400
 3    P3      0.27725     0.24789E-02  0.00000     -125.59
 4    P4      0.70933     0.51778E-02  0.00000     132.72
 5    P5      0.90472E-01 0.47875E-02  0.00000     -302.38
 6    P6      0.21181     0.75383E-02  0.00000     -63.830

CHISQUARE = 0.9282E+00  NPFIT = 1848

COVARIANCE MATRIX
*****
0.5367E-02
0.9472E-03  0.1387E-02
0.4548E-05 -0.9488E-06  0.6145E-05
-0.1520E-04 -0.2581E-04  0.1647E-05  0.2681E-04
-0.2597E-03 -0.7556E-04 -0.2361E-06  0.2208E-05  0.2292E-04
0.1100E-03 -0.3230E-04 -0.1566E-05  0.1904E-05 -0.2129E-04  0.5683E-04

*****
*
* Function minimization by SUBROUTINE HFITH *
* Variable-metric method *
* ID =          5  CHOPT = *
*
*****

```

Convergence when estimated distance to minimum (EDM) .LT. 0.10E-03

FCM= 69.87250 FROM MIGRAD STATUS=CONVERGED 64 CALLS 65 TOTAL  
 EDM= 0.38E-05 STRATEGY= 1 ERROR MATRIX ACCURATE

EXT	PARAMETER	STEP	FIRST
NO.	NAME	VALUE	ERROR
1	P1	199.30	3.5192
2	P2	0.39761	0.14150E-02
3	P3	0.98783E-01	0.10313E-02

CHISQUARE = 0.1075E+01 MPFIT = 68

EXAMPLE NO = 5

HBOOK ID = 5 DATE 18/05/92 NO = 17

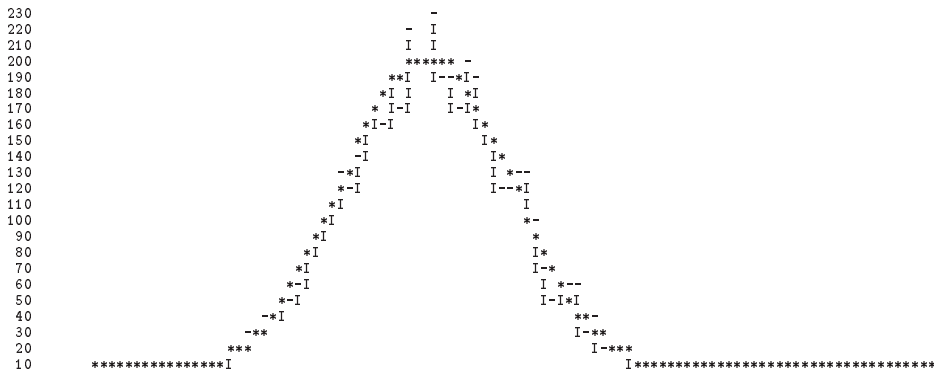

CHANNELS 100 0 1 2 3 4 5 6 7 8 9 10  
 1 1234567890123456789012345678901234567890123456789012345678901234567890123456789012345678901234567890

CONTENTS 100 11111111112112111211111111  
 10 1 112233456889131356586199288608541122964655231111  
 1. 1 2224268062313614000760053587389243868095597245890427768955738341 11 1

LOW-EDGE 1. 1111111111222222222333333333444444444555555555666666666777777777888888888999999999  
 \*10\*\* 1 0 01234567890123456789012345678901234567890123456789012345678901234567890123456789012345678901234567890

\* ENTRIES = 5000 \* ALL CHANNELS = 0.5000E+04 \* UNDERFLOW = 0.0000E+00 \* OVERFLOW = 0.0000E+00  
 \* BIN WID = 0.1000E-01 \* MEAN VALUE = 0.3984E+00 \* R . H . S = 0.9985E-01  
 \* CHISQUAR = 0.6987E+02

<b>Example of parametrization and smoothing</b>
---

```

SUBROUTINE HEXAM6
* .=====>
* .      PARAMETRIZATION      -      SMOOTHING
* .=====> ( R.Brun )
      DOUBLE PRECISION COEFF
      DIMENSION ITERM(15),COEFF(15)
* .-----
*
*           Get hist 110 from data base
*
      CALL HRGET(110,'hexam.dat',' ')
*
*           Find best parametrization of histogram in terms of powers
*           of shifted Tchebychev polynomials
*           also produces the corresponding fortran function (here on
*           standard output)
*
*
      CALL HCOPY(110,1,' ')
      CALL HSETPR('PNBX',15.)
      CALL HSETPR('PNCX',15.)
      CALL HSETPR('PLUN',31.)
      CALL HPARAM(1,3011,1.,14,COEFF,ITERM,NC0)
      CALL HPRINT(1)
*
*           ID=2 is smoothed with B-splines
*           statistical errors (sqrt of contents) are drawn
*
      CALL HCOPY(110,2,' ')
      CALL HSPLI1(2,2,14,3,CHI2)
      CALL HIDOPT(2,'ERRO')
      CALL HPHIST(2,'HIST',1)
      END

```



---

**Output Generated**

---

```
*****
*                                     *
*  MULTIDIMENSIONAL PARAMETRIZATION  *
*                                     *
*****
```

```
FIT CHARACTERISTICS AND OPTIONS
*****
```

```
ID = 1
DIM = 1
WORKING SPACE IN /PAWC/ = 5045
  0 USER-DEFINED BASIC FUNCTIONS
  0 USER-DEFINED ELEMENTARY FUNCTIONS
MAX NUMBER OF REGRESSORS = 15
MAX POWERS OF POLYNOMIALS IN EACH DIM = 14
AMOUNT OF OUTPUT = 1
WEIGHTING TYPE = 0
CLASS OF POLYNOMIALS = 3
CLASS OF BASIC FUNCTIONS = 0
BASIC FUNCTION SELECTION MODE = 0
REGRESSION MODE = 0
X-NORMALIZATION TYPE = 0
POWER LIMITOR = 1.00
F-TEST LEVEL = 1.00
PARAMETRIZATION SUPERIMPOSED ON HISTOGRAM
FORTRAN CODE FPARAM WRITTEN ON UNIT 31
```

```
FITTING PROCESS WILL STOP WHEN THE RESIDUAL VARIANCE HITS A MINIMUM
```

```
15 CANDIDATE BASIC FUNCTIONS WERE RETAINED FOR THE FIT
NUMBER OF POINTS TO FIT = 95
SUM OF SQUARES OF Y-VALUES = 5000.0
MACHINE PRECISION = 0.22E-15
```

```
FITTING PROCESS STOPPED AS RESIDUAL VARIANCE HITS MINIMUM
R2 = 0.98543 12 REGRESSORS INCLUDED
```

```
FINAL RESULTS OF THE FIT
*****
```

ITERATION	RSS	R2ADJ	REGRESSOR	COEFF. VALUE	TERM OF PARAMETRIZATION
13	72.841	0.98350	1	40.320	0
			2	-32.156	20
			3	29.461	60
			4	-20.018	80
			5	7.7912	100
			6	-18.482	50
			7	-7.0469	110
			8	-9.0691	10
			9	4.4675	130
			10	6.4382	90
			11	-3.9874	140
			12	3.1189	30

```
%%%%%%%%%%%%%%%%%%%%%%%%%%%%%%%%%%%%%%%%%%%%%%%%%%%%%%%%%%%%%%%%%%%%%%%%%
```

```

REGRESSOR  STANDARD DEVIATION      CONFIDENCE INTERVAL
  1         0.70650                [ 39.144 , 41.495 ]
  2         1.0509                 [ -33.904 , -30.407 ]
  3         0.85147                 [ 28.044 , 30.877 ]
  4         0.90853                 [ -21.530 , -18.506 ]
  5         0.82336                 [ 6.4213 , 9.1611 ]
  6         1.0259                  [ -20.189 , -16.775 ]
  7         0.78401                 [ -8.3514 , -5.7425 ]
  8         1.0731                  [ -10.854 , -7.2836 ]
  9         0.68036                 [ 3.3355 , 5.5995 ]
 10         0.83660                 [ 5.0463 , 7.8301 ]
 11         0.85716                 [ -5.4135 , -2.5612 ]
 12         1.1372                  [ 1.2267 , 5.0110 ]

DOUBLE PRECISION FUNCTION FPARAM (X)
DOUBLE PRECISION COEFF,P,PO,P1,P2,HELEFT,HBASFT
DIMENSION X(1),COEFF(12),IBASFT( 1,12)
DATA COEFF/ 0.40319615E+02,-0.32155589E+02, 0.29460772E+02,
+-0.20017895E+02, 0.77912196E+01,-0.18481896E+02,
+-0.70469122E+01,-0.90690550E+01, 0.44674803E+01,
+ 0.64381900E+01,-0.39873663E+01, 0.31188760E+01
+ /
DATA IBASFT/ 0, 20, 60, 80,100, 50,110, 10,130, 90,140, 30
+ /
FPARAM=0.
DO 25 K=1,12
P=1.
DO 15 I=1, 1
NUM=IBASFT(I,K)/10
ITYP=IBASFT(I,K)-NUM*10
IF (NUM.NE.0) THEN
IF (ITYP.EQ.0) THEN
PO=1.
P1=2*X (I)-1.
DO 10 J=2,NUM
P2=2*(2*X (I)-1.)*P1-PO
PO=P1
10 P1=P2
P=P*P1
END IF
IF (ITYP.EQ.1) P=P*HELEFT(NUM,X (I))
IF (ITYP.EQ.2) THEN
P=HBASFT(NUM,X )
GOTO 20
END IF
END IF
15 CONTINUE
20 FPARAM=FPARAM+COEFF(K)*P
25 CONTINUE
RETURN
END

```

THIS HISTOGRAM IS FILLED ACCORDING TO THE FUNCTION HTFUNG1

HBOOK ID = 1 DATE 17/12/91 NO = 18



CHANNELS	0	1	2	3	4	5	6	7	8	9	10
100	0										1
10	0										0
1	1	2	3	4	5	6	7	8	9		

CONTENTS	100	10	1.
100		1111111111111111	
10		1122246580124457554320996875432221212122123345566655777667868667666454334322221111	
1.		21124626818147606828212710478511552225771649871850922032539736953183588893942434650812591167574	

LOW-EDGE	1.
1.	11111111112222222222333333333444444455555555566666666677777777788888888899999999999999

*10**	1	0
100	0	012345678901234567890123456789012345678901234567890123456789012345678901234567890123456789

* ENTRIES =	5000	* ALL CHANNELS =	0.5000E+04	* UNDERFLOW =	0.0000E+00	* OVERFLOW =	0.0000E+00
* BIN MID =	0.1000E-01	* MEAN VALUE =	0.4834E+00	* R . H . S =	0.2184E+00		
* CHISQUAR =	0.7284E+02						

THIS HISTOGRAM IS FILLED ACCORDING TO THE FUNCTION HTFUN1

HBOOK ID = 2 DATE 17/12/91 NO = 19

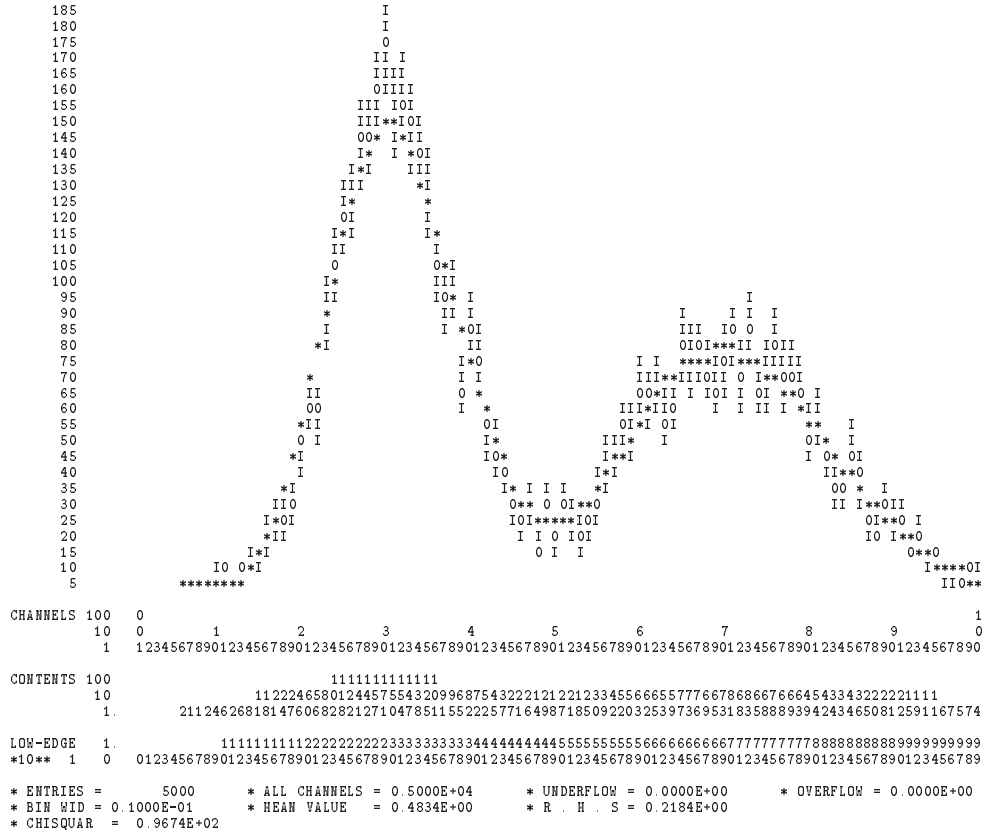

## Chapter 8: Memory Management and input/output Routines

### 8.1 Memory usage and ZEBRA

The hbook system uses the zebra data manager to store its data elements in a COMMON block /PAWC/ (shared with the kuip and higz packages, when the latter are also used, as is the case in paw). In fact the first task of a hbook user is to declare the length of this common to zebra by a call to HLIMIT, as is seen in figures 1.2 and 1.4

In the /PAWC/ data store, the hbook, higz and kuip packages have all their own **division** (see [10] for more details on the notion of divisions) as follows (see figure 8.1):

- LINKS Some locations at the beginning of /PAWC/ for zebra pointers.
- WORKS Working space (or division 1) used by the various packages storing information in /PAWC/
- HBOOK Division 2 of the store. Reserved to hbook.
- HIGZ A division reserved for the higz graphics package. This division only exists when higz is called.
- KUIP A division reserved for the kuip user interface package. This division only exists when kuip is called.
- SYSTEM The zebra system division. It contains some tables, as well as the Input/Output buffers for HRIN and HROUT.

```
COMMON/PAWC/NWPAW,IXPAWC,IHDIV,IXHIGZ,IXKU,FENC(5),LMAIN,HCV(9989)
DIMENSION IQ(2),Q(2),LQ(8000)
EQUIVALENCE (LQ(1),LMAIN),(IQ(1),LQ(9)),(Q(1),IQ(1))
```

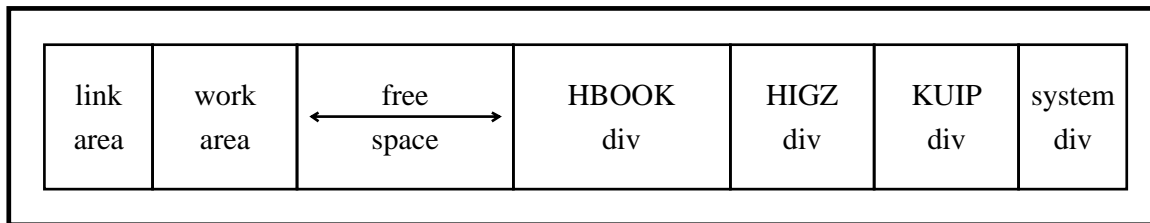

Figure 8.1: The layout of the /PAWC/ dynamic store

#### 8.1.1 The use of ZEBRA

Inside the hbook division the various data elements are stored as a zebra data structure, one for each “identifier”. In fact all identifiers (histogram or Ntuple numbers) are stored in an ordered array in a zebra bank and access to the information associated with the hbook data is via the **reference link** at the same offset as the identifier in the data part of the bank. The data structure for a given element depends on its characteristics. In any case the top bank for a given element contains the title and other constants, while the data themselves are stored in another bank hanging from the previous one. Sometimes other banks are

created, e.g. for automatic binning, for storing the limits of the elements of a Ntuple and, when a Ntuple is kept in memory, for containing the overflow of the data, for **projections**, **slices** and **bands** in the 2-dim case or for containing the **errors** associated to a bin. This means that each hbook identifier has a whole set of **attributes** associated with its existence, and when a histogram or Ntuple is written to backup store and later reread, the **complete data structure**, containing all characteristics and attributes are retrieved. Figure 8.2 shows the zebra data structure for a two-dimensional histogram. The precise layout of this bank should be of no concern to the user. It is only shown here as an example of the underlying zebra structure of hbook. Note the use of the **data** part of the bank for storing attributes (e.g. title, number of bins, number of entries) as well as of the **link** part for storing the addresses to access the associated data points (scatter plot contents, X and Y projections, slices and bands and their associated errors).

## 8.2 Memory size control

```
CALL HLIMIT (NWPAW)
```

**Action:** Defines the maximum total size NWPAW of common /PAWC/.

**Remark:**

- HLIMIT must be called before any other hbook routine.
- hbook is compiled with a COMMON/PAWC/ dimensioned to 10000 words. If NWPAW<10000, then the default value of 10000 is assumed.
- If zebra has already been initialised, HLIMIT must be called with a negative argument, e.g. CALL HLIMIT(-NWPAW).

```
CALL HLOCAT (ID,LOC*)
```

**Action:** Returns the pointer in common /PAWC/ to the zebra ([10]) structure, which contains the description of a given histogram.

**Input parameter:**

ID histogram identifier

**Output Parameter:**

LOC Pointer to the zebra bank containing the histogram information.

This routine can be useful to access directly the memory area of a given histogram, to extract any information that cannot be obtained with the entries previously described.

### 8.2.1 Space requirements

The argument NWPAWC must be given a value large enough to accommodate in memory all histograms (1-D and 2-D) and all Ntuple headers and buffers, i.e.

$$NWPAWC > 10000 + \sum_{i=1}^{N1} S_F(i) + \sum_{i=1}^{N1} S_1(i) + \sum_{i=1}^{N2} S_2(i) + \sum_{i=1}^{NT} S_N(i)$$

Figure 8.2: The zebra data structure used for two-dimensional histograms

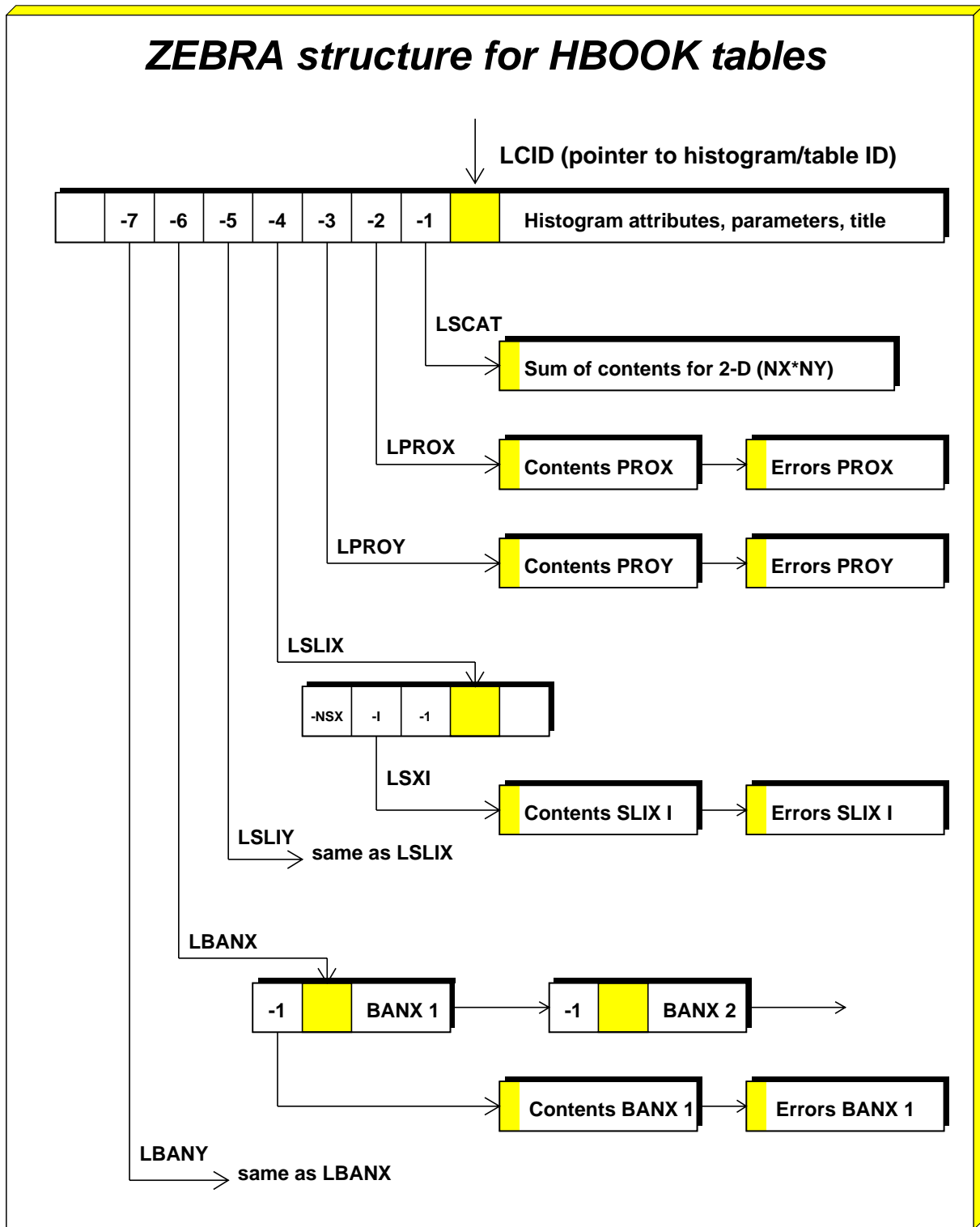

NF	Number of open files
$S_F(i)$	$100 + \text{LREC}_i$ , where LREC is the buffer size for file $i$ , as specified in a call to HROPEN.
N1	Number of 1-D histograms
$S_1(i)$	Space occupied by 1-D histogram $i$ , i.e. $40 + (\text{NCHAN} + 2) * \text{PACK} + \text{IERR} * (\text{NCHAN} + 10) + \text{IFUN} * (\text{NCHAN} + 10)$
NCHAN	Number of channels in histogram
PACK	Packing factor (1. by default). See parameter VMX of HBOOK1.
IERR	1 if HBARX called, 0 otherwise.
IFUN	1 if the histogram has an associated function (HFUNC, fits or smoothing)
N2	Number of 2-D histograms
$S_2(i)$	Space occupied by 2-D histogram $i$ , i.e. $40 + (\text{NCHANX} + 2) * (\text{NCHANY} + 2) * \text{PACK} + \text{space for projections, slices and bands (which are 1-D histograms)}$ .
NT	Number of Ntuples
$S_2(i)$	Space occupied by headers and buffers of Ntuple $i$ (see routines HBOOKN and HBNT).

### 8.3 Directories

hbook histogram data are kept in a zebra tree structure similar to the directory structure of the Unix file system. Note that the zebra RZ package uses the same conventions. (In fact, hbook uses the zebra RZ package to manage files). With this convention, all references to histograms are still made using an integer identifier, but this identifier is relative to a **directory**. hbook initially sets the current directory to be //PAWC. This directory remains the current directory until changed either explicitly or implicitly by one of the calls described below. As with the Unix file system the current directory can be a subdirectory, e.g. //PAWC/L1, //PAWC/L1/L21 and //PAWC/L1/L22.

These hbook directories can reside in the local memory of the computer (i.e. the PAWC common, or they can be stored on a local (//LUN1) or remote disk file system (//VXCRNA). They can even be dynamically created by a "producer" in the memory of a remote computer and "shared" by that machine with the user's machine via global section (VMS) or shared memory (Unix).

			HMDIR	HCDIR	HLDIR	HDDIR	HPDIR	
-----	//PAWC		local memory	X	X	X	X	X
		//LUN1	local disk	X	X	X	X	X
	USER		//VXCRNA ---- telnet (rsh)	remote disk	X	X	X	
		//GLOSEC ---- tcp/ip ---	global section(VMS)	X	X	X		
-----	//SHARE	---- tcp/ip ---	shared memory (Unix)	X	X	X		

Figure 8.3: Different kinds of hbook directories



```
CALL HMDIR (CHPATH,CHOPT)
```

**Action:** Make a new subdirectory below the current directory. This command works with all five different kinds of directories described in figure 8.3.

**Input parameters:**

CHPATH Character variable or constant containing the name of the subdirectory.

CHOPT Character variable specifying the option chosen. If CHOPT='S' then the current directory is changed to the new directory.

```
CALL HCDIR (*CHPATH*,CHOPT)
```

**Action:** Change the current directory. This command works with all five different kinds of directories described in figure 8.3.

**Input parameters:**

CHPATH Character variable or constant containing the name of the directory which is to become the current directory (default action if CHOPT=' ').

CHOPT Character variable specifying the option chosen.

' ' Set new directory.

'R' Read the name of the current directory.

**Output Parameter**

CHPATH Character variable containing the name of the current directory (CHOPT='R').

Setting RZ directories	
CALL HCDIR('//PAW/CDET', ' ')	! Go to directory with given absolute pathname
CALL HCDIR('TPC', ' ')	! Go to directory with given relative pathname ! we are now in //PAW/CDET/TPC
CALL HCDIR('//PAW/CDET/TPC', ' ')	! Equivalent to 1+2 above
CALL HCDIR('\', ' ')	! Go to parent directory, i.e. //PAW/CDET
CALL HCDIR('TPC', ' ')	! Go to TPC subdirectory again
CALL HCDIR ('\VERTEX', ' ')	! Go to directory //PAW/CDET/VERTEX ! i.e. one level up then one down again

This concept of directories also applies to the direct access files when using HRFILE, HRIN and HROUT.

```
CALL HLDIR (CHPATH,CHOPT)
```

**Action:** List the contents (identifiers, type of histograms and titles) of a hbook directory. This command works with all five different kinds of directories described in figure 8.3.

**Input parameters:**

CHPATH Character variable or constant containing the name of the directory to be listed. CHPATH=' ' stands for the current directory.

CHOPT Character variable specifying the chosen option.

' ' List only the top directory.

'A' List all Ntuple extensions.

'I' HINDEX option selected instead of simple list.

'N' List only the Ntuples.

'R' List using RZ format.

'S' Sort the directory entries.

'T' List the complete subdirectory tree starting from the specified directory.

```
List all existing directories in //PAWC
```

```
CALL HLDIR ('//PAWC','T')
```

```
CALL HDDIR (CHPATH)
```

**Action:** Delete a (sub)directory from memory or local disk.

**Input parameter:**

CHPATH Character variable or constant specifying the pathname of the (sub)directory to delete. CHPATH=' ' stands for the current directory.

```
CALL HPDIR (CHPATH,CHOPT)
```

**Action:** Print the contents of a directory (This routine calls HPRINT). This routine works only for directories in local memory or remote RZ files accessed opened via XZRZOP (see the CSPACK manual [19] for more information).

**Input parameters:**

CHPATH Character variable or constant specifying the pathname of the directory to be printed. CHPATH=' ' stands for the current directory.

CHOPT Character variable specifying the option chosen.

' ' Print the contents of the top directory.

'I' Print an index.

'T' Print the complete directory tree (i.e. the top directory and its subdirectories).

<b>Printing list of histograms</b>
------------------------------------

```
CALL HPDIR ('//PAWC','T') ! Print list of all histograms in //PAWC
CALL HPDIR (' ',' ')      ! Print list of all histograms in current directory
CALL HPRINT(0)           ! Print histograms in current directory
```

CALL <b>HLNEXT</b> (*IDH*,CHTYPE*,CHTITL*,CHOPT)
--

**Action:** Scan the contents of the current directory in memory or on an RZ file.

**Input parameters**

IDH        Must be zero for first call

CHTYPE    Character variable specifying items to be scanned.

- '1'    include 1-D histograms
- '2'    include 2-D histograms
- 'N'    include Ntuples
- 'D'    include subdirectories
- ' '    include everything, i.e., equivalent to '12ND'.

**Output parameters**

IDH        On return contains identifier of next histogram. When all histograms are processed, a value of zero is returned.

CHTYPE    Character variable specifying type of histogram.

- '1'    1-dimensional
- '2'    2-dimensional
- 'N'    Ntuple
- 'D'    subdirectory
- '?'    unknown.

CHTYPE    Character variable containing title or subdirectory name.

<b>Scan content of current directory</b>
--

```

IDH=0
1  CONTINUE
   CALL HLNEXT(IDH,CHTYPE,CHTITL,CHOPT)
   IF(IDH.NE.0) THEN
     ... process
     GOTO 1
   ENDIF
```

```
CALL HRDIR (MAXDIR,CHDIR*,NDIR*)
```

**Action:** Returns the list of subdirectories of the current working directory. This command works with all five different kinds of directories described in figure 8.3.

### Input parameter

MAXDIR Length of the character array CHPATH.

### Output parameters

CHDIR\* Character array which will contain the names of the subdirectories of the current working directory.

NDIR\* Actual number of subdirectories present in the current working directory. If this number is greater than MAXDIR, only the first MAXDIR subdirectory names will be returned in array CHDIR.

The use of directories is illustrated below:

#### Example of use of directories

```
PROGRAM MAIN
*
COMMON/PAWC/H(20000)
CALL HLIMIT (20000)
CALL HBOOK1 (10,'Energy distribution',100,0.,300.,0.)
  " "
*
CALL USECAL
  " "
CALL HFILL (10,EDER,0.,1.)
  " "
CALL HISTDO
  " "
END
SUBROUTINE USECAL
*
*   Make a new directory ECAL and set the new current directory
*
CALL HMDIR ('ECAL','S')
*
*   Create a new histogram with ID=10 in the new directory
*
CALL HBOOK1 (10,'My histogram',50,-5.,5.,0.)
  " "
CALL HFILL (10,UX,0,1.)
  " "
*
*   Go back to the parent directory
*
CALL HCDIR ('\', ' ')
  " "
END
```

## 8.4 Input/Output Routines

hbook files are in fact zebra RZ files [10]. Input/output error return codes are available via the zebra communication vector IREQUEST, and the user should consult the RZ manual for their meaning. Both disk and memory resident files are supported, the latter being particularly useful in online applications, where histogram data have to be shared between different processes.

hbook files are written in Zebra exchange format and thus need not be converted when transferred between different computer systems using binary ftp (see section 8.5), or accessed over the network using a distributed file system such as AFS or NFS.

### Reading and writing histograms to a direct access file

```
CALL HRPUT (ID,CHFILE,CHOPT)
```

**Action:** Write a histogram to a given direct access file. This routine cannot be used for Ntuples.

#### Input parameters:

- ID Histogram identifier. ID=0 writes all histograms in the current directory to the output file.
- CHFILE Character variable or constant defining the filename.  
If CHFILE=' ' the histogram is saved in the current working directory on disk.
- CHOPT Character option specifying the desired option.
- 'N' Write the histogram to a New file.
  - 'T' Can be used together with ID=0. All histograms in the current directory and all subdirectories in memory are written to the output file.
  - 'U' Write the histogram to an already existing hbook file. When an histogram with the same identifier already exists on the output file, then a new cycle is added.

```
CALL HRGET (ID,CHFILE,CHOPT)
```

**Action:** Read a histogram from a given direct access file. This routine cannot be used for Ntuples.

#### Input parameters:

- ID Histogram identifier. ID=0 read all histograms into the current directory.
- CHFILE Character variable or constant defining the input filename.  
If CHFILE=' ' the histogram is read from the current working directory on disk.
- CHOPT Character option specifying the desired option.
- 'A' Add to the current histogram in memory.
  - 'T' Get a complete tree (**not yet implemented**)

#### Remarks:

The following remarks apply to both HRPUT and HRGET.

- HRGET and HRPUR issue automatically Fortran OPEN and CLOSE calls.
- With HRPUR the file is created with LREC=1024 machine words.
- On VM/CMS no FILEDEF statement should be given. The filename CHFILE can be given in either of the forms `Filename Filetype Filemode` or `Filename.Filetype.Filemode`
- On Unix the filename CHFILE will be translated to lowercase.
- Fortran logical unit 88 is used by these routines.
- HRPUR calls HROPEN, HROUT and HREND.
- HRGET calls HROPEN, HRIN and HREND.

### Open an RZ direct access file or map a Global Section

```
CALL HROPEN (LUN,CHTOP,CHFILE,CHOPT,*LREC*,ISTAT*)
```

**Action:** Open a direct access hbook file. If several direct access files are opened, they are identified by the top directory only.

#### Input parameters:

- LUN Logical unit number associated to the file.
- CHTOP Character variable specifying the name of the **top** directory associated with unit LUN (maximum 8 characters). This is an arbitrary name used to identify the file on unit LUN in subsequent calls to HR . . . routines.
- CHFILE Character variable specifying the name of the file to be opened.
- CHOPT Character variable specifying the options selected
- Medium** ' ' Disk (default)
- 'G' Global Section (see chapter 9)
- mode** ' ' Existing HBOOK file (default)
- 'N' Create a new file
- 'Q' Override default number of records for new file with contents of IREQUEST(10)
- 'X' The file is/will be in exchange format
- 'U' Update an existing file
- LREC Record length in machine words (recommended value is 1024). If LREC=0 the actual record length is returned on exit.

#### Output parameters:

- ISTAT Return code. ISTAT=0 indicates success.
- LREC (**Only when (LREC=0) on input**) The actual record length of the file on disk.

#### Remarks:

- HROPEN performs a Fortran direct access open for the file CHFILE on logical unit LUN.
- On VM/CMS no FILEDEF statement should be given. The filename CHFILE can be given in either of the forms `Filename Filetype Filemode` or `Filename.Filetype.Filemode`

- On Unix the filename CHFILE will be translated to lowercase.
- If LREC=0 on input, HROPEN will automatically determine the record length of existing files.
- On MVS systems, the current userid prefix will be automatically added to the front of the file name unless the first character is a dot (.).
- The maximum number of records is by default 32000. You can use option 'Q' to change this.
- A file declared with HROPEN must be released with HREND.
- HROPEN calls HRFILe internally.

```
CALL HRFILe (LUN,CHTOP,CHOPT)
```

**Action:** Establishes a temporary unique correspondance between a logical unit and a **top directory** name. Users should call HROPEN instead of HRFILe.

By default, HROPEN (HRFILe) creates new files (option N) with the maximum number of records set to a large number (default 32000). If this is insufficient, the user can override this value by specifying the Q option and setting IQUEST(10) to the actual number of records required (up to a maximum of 65K).

#### Overriding the default record allocation

```
COMMON/QUEST/IQUEST(100)           ! Declare IQUEST communication vector
IQUEST(10) = 65000                  ! I require 65000 records
CALL HROPEN(1,'FILE','file.ext','NQ',1024,ISTAT) ! Call HROPEN
```

Note that after a call to HROPEN (HRFILe) (if CHTOP='MYDST' for example), the current directory is set to //MYDST. If LUN is an existing file, one can change the current directory to an existing subdirectory, SUBDIR, using CALL HCDIR ('SUBDIR', ' '), setting the current directory CD to //CHTOP/SUBDIR.

- The **contents** of a directory is **listed** using routine HLDIR.
- A **new subdirectory** can be created with routine HMDIR.
- The **current directory** in memory (//PAWC/) and hence on the direct access files may be set by one of the routines HCDIR or HMDIR.

Note that when calling HCDIR or HRFILe on a direct access file, the current directory in memory will be **the latest current directory set**.

#### Writing to a file

```
CALL HROUT (ID,ICYCLE*,CHOPT)
```

**Action:** Write a histogram from the current directory in memory onto the current directory on the direct access file.

#### Input parameters:

- ID        Histogram identifier. ID=0 means write all histograms from the current directory in memory.
- CHOPT    Character variable specifying the options selected.
- 'N'    Create on the direct access file the same directory tree as in memory.

'T' Write the whole directory tree hanging from the current directory (if ID=0).

### Output parameter:

ICYCLE Cycle number. The first time a given histogram with identifier ID is stored on a directory on a direct access file, ICYCLE is set to 1. If the histogram identifier ID already exists on the direct access file, then the call to HROUT will increment the cycle number ICYCLE by one.

Experienced users may invoke routines from the zebra RZ package to **purge** a directory, i.e. delete all versions of an identifier but the most recent one using routine RZPURG.

### Reading from a direct-access file or global section

```
CALL HRIN (ID,ICYCLE,IOFSET)
```

**Action:** Read a histogram from the current directory on the direct access file (or global section) into the current directory in memory.

### Input parameters:

ID Histogram identifier. ID=0 means that all histograms from the current directory on the direct access file (global section) should be read into memory. If a histogram identifier ID already exists in memory a message is printed and it is deleted from memory before reading the new histogram from the file or global section.

ICYCLE Cycle number. If ICYCLE=0 then the lowest cycle is read. To read the highest cycle, use a large number, e.g. 999999.

IOFSET The histogram which is read in memory will have the identifier IDN=ID+IOFSET. Specifying IOFSET different of zero permits to have in memory copies of histograms with the same identifiers ID in different files. This parameter may be very useful when HRIN is called together with routines such as HOPERA or HDIFF. **This facility also works for Ntuples.**

### Merging HBOOK files into a new file

```
CALL HMERGE (NFILES,CHFIN,CHFOUT)
```

**Action:** Merges two or more HBOOK files with identical objects and directories into a new file. Histograms are added and Ntuples are combined. Works for CWN's and RWN's.

### Input parameters:

NFILES Number of input files to be merged.

CHFIN Character array (e.g., CHARACTER\*8 CHFIN(10) for 10 files whose names are not longer than 8 characters) containing the name(s) of the file(s) to be merged.

CHFOUT Character variable with the name of the output file.

```
CALL HMERGIN
```

**Action:** Identical to HMERGE but the routine prompts interactively for the names of the input and output files. The paw command NTUPLE/HMERGE calls this routine.



**Scratching histogram in a file**

```
CALL HSCR (ID,ICYCLE,CHOPT)
```

**Action:** Scratch (delete) a histogram from the current directory in the direct access file.

**Input parameters:**

ID Histogram identifier. ID=0 means scratch all histograms in the current directory.  
ICYCLE Cycle number. If ICYCLE=0 then all cycles are deleted.  
CHOPT Character variable specifying options selected.  
' ' Only possible value (not used at present)

**Close a file**

```
CALL HREND (CHTOP)
```

**Action:** Closes a direct access file if is not needed anymore or when the options 'N' or 'U' are specified in HRFILF.

**Input parameter:**

CHTOP Character variable specifying the name of the top directory associated with the file to be closed. This should correspond to the name declared with HRFILF. After this call, the system bank associated to this file is deleted. The call to HREND is obligatory when the file has been modified.

**Remark:**

A Fortran CLOSE statement should follow a call to HREND.

## 8.5 Exchange of histograms between different machines

hbook files are by default created in exchange mode. They can be transported between machines using the standard binary FTP or they can be NFS mounted in a heterogeneous environment.

### Transfer between Unix machines with FTP

```
$ ftp remote
ftp> bin
ftp> get remote.hbook
```

### Transfer from CERNVM to a Unix workstation

On CERNVM type the following:

```
CMS FTP workstation
ftp> BIN F 4096      ! block size in bytes
ftp> PUT file.hbook
```

### Running FTP on a VAX/VMS system

```
$ ftp remote
ftp> bin
ftp> get remote.hbook
ftp> quit
$ resize -s 4096 remote.hbook;1
```

The `resize` command does not copy the file. It simply changes the header information, from 512 byte records to 4096 bytes. In case the block size of the hbook file is not 1024 words (LREC parameter of routine HROPEN), i.e. 4096 bytes, specify the corresponding value as parameter to the `resize` command. The `resize` tool is available on request from the CERN Program Library.

#### **Proposed hbook file naming convention**

Users are encouraged to name their hbook files with the suffix `.hbook`, so that the `paW++` browser will be able to recognize these files automatically.

## 8.6 RZ directories and HBOOK files

Another advantage of the use of zebra in hbook is that zebra's direct access **RZ package** is available. The RZ package allows data structures to be uniquely addressed via **pathnames**, which are based on Unix file names. Related data structures are addressed from a **directory**.

Routine HROPEN issues a the Fortran OPEN statement and declares the RZ top directory.

### Example of using HROPEN

```
CALL HROPEN(LUN, 'HISTO1', 'HISTOS.DAT', CHOPT, LRECL, ISTAT)
```

In this example, HROPEN issues a Fortran direct-access open statement for the file HISTOS.DAT. If, on input, LRECL contains the value 0, HROPEN will automatically determine the record length of the file, provided that the file already exists.

Each time a RZ file is opened via a call to HROPEN or HRFILE, a supplementary top directory is created with a name specified in the calling sequence. This means that the user can more easily keep track of his data and also the **same** histogram identifiers can be used in various files, what makes life easier if one wants to study various data samples with the same program, since they can be addressed by changing to the relevant file by a call to HCDIR first. For more information on the RZ package, see the zebra RZ manual.

In the case of the second call to HROPEN, where update mode is requested, it is the users responsibility to ensure that write-access is enabled, i.e. the file is not on a read-only mini-disk (VM/CMS systems), or is opened with the SHARED attribute (VAX/VMS systems) etc.

A Fortran CLOSE statement is also required for each file after calling HREND. Further details of hbook's usage of zebra RZ files are given below.

### Defining hbook files

```
CALL HROPEN(1, 'HISTO1', 'HISTO1.DAT', ' ', 1024, ISTAT)      ! Open first HBOOK RZ file (read only)
CALL HROPEN(2, 'HISTO2', 'HISTO2.DAT', 'U', 1024, ISTAT)    ! Open second HBOOK RZ file (update)
CALL HCDIR('//HISTO1', ' ')                                  ! Make HISTO1 current directory
CALL HRIN(20, 9999, 0)                                       ! Read ID 20 on file 1
...
CALL HCDIR('//HISTO2', ' ')                                  ! Make HISTO2 current directory
CALL HRIN(10, 9999, 0)                                       ! Read ID 10 on file 2
...
CALL HROUT(20, ICYCLE, ' ')                                  ! Write ID 20 to file 2
CALL HREND('HISTO1')                                        ! Close file 1
CALL HREND('HISTO2')                                        ! Close file 2
```

In the previous example (and also in figures 1.2 and 1.4) it is shown how an external file is available via a directory name inside hbook (and paw), and that one can change from one to the other file by merely **changing directory**, with hbook routine HCDIR

## Using subdirectories

The use of subdirectories, both in memory and on disk, is shown in the following examples.

### Example of using subdirectories

```

PROGRAM TEST
INTEGER  NWPAWC
PARAMETER (NWPAWC=15000)
COMMON/PAWC/PAW(NWPAWC)
CHARACTER*8 CHTAGS(5)
DIMENSION EVENT(5)
EQUIVALENCE (EVENT(1),X),(EVENT(2),Y),(EVENT(3),Z)
EQUIVALENCE (EVENT(4),ENERGY),(EVENT(5),ELOSS)
DATA CHTAGS/'X','Y','Z','Energy','Eloss'/
*-- Tell HBOOK how many words are in PAWC.
CALL HLIMIT(NWPAWC)
CALL HROPEN(1,'EXAMPLE','EXAMPLE.DAT','N',1024,ISTAT)
IF(ISTAT.NE.0)GO TO 99
*-- Make sub-directory on disk (as HROUT does not do this for us).
CALL HMDIR ('US','S')
CALL HCDIR('//PAWC',' ')
*-- Make sub-directory in memory.
CALL HMDIR ('US','S')
CALL HCDIR('//PAWC/US',' ')
*-- Book Ntuple + 1d histogram
CALL HBOOKN(10,'A simple Ntuple',5,'EXAMPLE',5000,CHTAGS)
CALL HBOOK1(100,'Energy distribution',100,0.,100.,0.)
*-- Fill the Ntuple and histogram
DO 10 I=1,1000
CALL RANNOR(X,Y)
Z=SQRT(X*X+Y*Y)
ENERGY=50. + 10.*X
ELOSS=10.*ABS(Y)
CALL HFN(10,EVENT)
CALL HFILL(100,ENERGY,0.,1.)
10 CONTINUE
*-- Juggle top directories (order of these calls is important!!).
CALL HCDIR('//PAWC',' ')
CALL HCDIR('//EXAMPLE',' ')
*-- Write out everything to disk
CALL HROUT(0,ICYCLE,'T')
*-- Flush remaining buffers to disk.
CALL HREND('EXAMPLE')
99 CONTINUE
END

```

## Chapter 9: Global sections and shared memory

### 9.1 Sharing histograms in memory on remote machines

When HBOOK is used in a data acquisition system environment, **global sections** can be an interesting alternative to disk input/output. The following example is a simple illustration of this facility.

Let us assume two processes exist:

- 1 PFILL, the process **filling** some histograms in COMMON/PAWC/ directly.
- 2 PRESENT, a process activated from time to time to **visualize** the histograms created and filled by PFILL.

No hand-shaking mechanism is required. A global section is created (this is system dependent). This global section is mapped to COMMON/PAWC/ in process PFILL and to COMMON/PAWMAP/PAWM(*nwords*) in PRESENT. This process has also a COMMON/PAWC/, which will be used as a working space common.

A call CALL HRFILE (PAWM, 'PFILL', 'GN') in process PRESENT will open a HBOOK global section. The **current directory** is now set to //PFILL. Routine HCDIR may be used to change the current directory to lower level directories. Using HRIN (described below) a histogram can now be copied from PFILL to /PAWC/ of process PRESENT and invoke the printing or plotting routines of either HBOOK or HPL0T.

Tools exist (for example in PAW) to dynamically map global sections. It should be noted however that this mechanism does not allow to write (e.g. using routine HROUT) from process PRESENT into PFILL.

It is possible to open more than one global section (several processes PFILL).

#### 9.1.1 Memory communication

```
CALL HCOPYM (ID,IPAWD,IOFSET)
```

**Action:** Copies one or more histograms from the PAW area to common /PAWC/.

##### Input parameters:

ID            Identifier of the histogram. ID=0 means copy all existing histograms.  
IPAWD        PAW area identifier.  
IOFSET       Offset of newly created histogram(s), i.e. new histogram(s) will have identifier(s) ID+IOFSET.

### 9.2 Mapping global sections on VMS

```
VALUE = hcreatg (global_name,base_common,size)
```

**Action:** Function to create and map a global section .

The function first opens a file with Uf0 option (using HST\_OPEN\_GBL), then creates and maps the global section using SYS\$CRMPSC. Open the file using SYS\$SETDFPROT to set protection loose.

##### Input parameters:

global\_name    Name of the section to be mapped

`base_common`     First word of `COMMON` to be mapped.  
`size`             size of the `COMMON` in words.

The function value returned is equal to the global section length (pages) if the procedure was successful or an errorcode  $<0$  if an error occurred.

`HCREATEG$DIR` is a `LOGICAL` which, if defined, gives the directory for the mapping file of the global section. In this case, the file is not deleted upon closing.

```
VALUE = hmapg (global_name,base_common,offset)
```

**Action:** Function to dynamically map to an existing global section.

The function maps to the global section using `SYS$MGBLSC`, allocating pages in the `p0` region with the `sec$m_expreg` option.

**Input parameters:**

`global_name`     Name of the section to be mapped  
`base_common`     First word of reference `COMMON` to be mapped.  
`offset`            Offset with respect to `BASE_COMMON` of the mapped section in words,  
                     i.e. `BASE_COMMON(OFFSET)` is the first word.

The function value returned is equal to the global section length (pages) if the procedure was successful or is an errorcode  $<0$  if an error occurred.

```
VALUE = hfree (global_size,base_common,offset)
```

**Action:** Function to dynamically delete/unmap global section space using the service `SYS$DELTVA`.

**Input parameters:**

`global_size`     Size of the section to be freed (pages).  
`base_common`     First word of reference `COMMON`.  
`offset`            Offset with respect to `BASE_COMMON` of the mapped section in words,  
                     i.e. `BASE_COMMON(OFFSET)` is the first word.

The function value returned is equal to the global section length (pages) if the procedure was successful or is an errorcode  $<0$  if an error occurred.

### 9.2.1 Using PAW as a presenter on VMS systems (global section)

```

PROGRAM PRODUCE
PARAMETER MAXPAGES=100
COMMON/PAWC/IPAWC(128*MAXPAGES)
CHARACTER*8 GNAME
INTEGER*4 HCREATEG
*
GNAME='GTEST'
WAIT_TIME=1.
NUMEVT=1000
*.....          Create Global section
NPAGES=HCREATEG(GNAME,IPAWC,128*MAXPAGES)
IF(NPAGES.GT.0) THEN
  PRINT 1000,GNAME
1000  FORMAT(' Global Section: ',A,' created')
ELSE
  IERROR=-NPAGES
  PRINT 2000,IERROR
2000  FORMAT(' Global Section Error', I6)
  GO TO 99
ENDIF
CALL HLIMIT(128*NPAGES)
*.....          Book histos.
CALL HBOOK1(10,'Test1$',50,-4.,4.,0.)
CALL HBOOK1(20,'Test2$',50,-4.,4.,0.)
*.....          Fill histos.
DO 20 I=1,NUMEVT
  DO 10 J=1,100
    CALL RANNOR(A,B)
    CALL HFILL(10,A,0.,1.)
    CALL HFILL(20,B,0.,1.)
  10  CONTINUE
  CALL LIB$WAIT(WAIT_TIME)
  20  CONTINUE
*
99  STOP
END

$ fort produce
$ link produce,SYS$INPUT/OPTIONS,-
cern$library:packlib/lib,kernlib/lib
PSECT=PAWC,PAGE

```

```

PAW > edit produce
macro produce ntimes=100
  nt=[ntimes]
  zone 1 2
  histo/plot 10 K
  histo/plot 20 K
loop:
  histo/plot 10 U
  histo/plot 20 U
  wait ' ' 1
  nt=[nt] -1
  if nt>0 goto loop
return
PAW > global_sect GTEST
PAW > exec produce ntimes=20

```

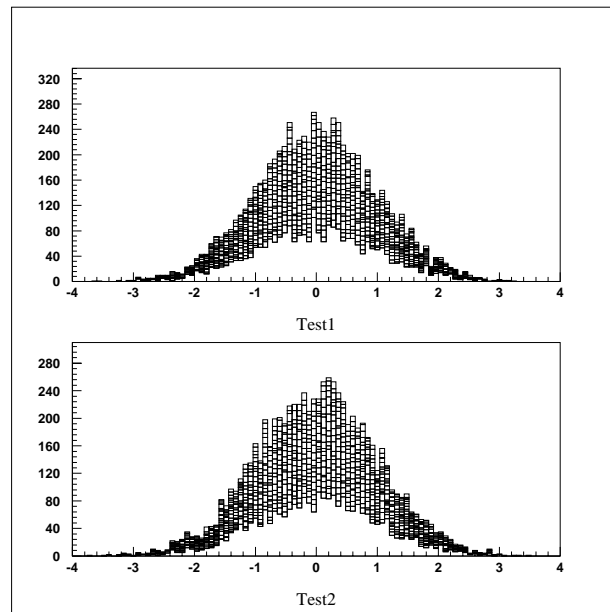

Figure 9.1: Visualise histograms in global section

In addition to the facilities described in the previous section, the standard version of PAW may be used as an online presenter on VMS systems using the mechanism of global sections. It is possible for two processes to reference the same histograms using **global sections**. For example, the first process may be a **histogram producer** (e.g. a monitoring task) and the second process **PAW**. As the histograms are being gradually filled by the first task, PAW can view them, and even reset them. To use the global sections, it is also necessary to "page align" the common which is in the global section. This is achieved in the "link step" when making the process (see example). The relevant statements are `SYS$INPUT/OPTIONS` to tell the linker that some options follow the link statement, and `PSECT=PAWC,PAGE` which is the option to page align the `/PAWC/` common.

### 9.3 Unix shared memory (Sun and DecStation only!)

On Unix systems, with the exception of HP-UX and SOLARIS, it is possible to communicate between processes using shared memory. In the histogram producer program, use routine HLIMAP instead of HLIMIT to initialize HBOOK. With PAW use the command global\_sect to use shared memory.

```
CALL HLIMAP (NWORDS, CHNAME)
```

**Action:** The routine maps a file to a shared memory area.

#### Input parameters:

NWORDS Number of words for the shared area.

If NWORDS=0 an existing shared memory is attached and becomes the current HBOOK directory. In this case HLIMIT must have been called previously.

CHNAME Character variable (CHARACTER\*4) specifying the name given to the shared area.

All histograms, Ntuples, etc. in this area have a structure similar to the /PAWC/ common.

#### Example with pre-existing shared area

```

Program toy
Parameter (nwpaw=100000)
common/pawc/paw(nwpaw)
call hlimit(nwpaw)
*
  call hlimap(0,'TEST')
*
1 read *,id
  call hrin(id,9999,0)
  call hprint(id)
  call hdelet(id)
  if(id.ne.0)go to 1
end

```

Note that HBOOK does not delete the shared memory when the job finishes, that remains the user's responsibility.



### 9.3.1 Using PAW and Unix shared memory (Sun and DecStation only)

```

Program hserver
*
* HBOOK program creating a "shared memory"
* area called 'TEST'
* Routine HLIMAP replaces HLIMIT.
* NWORDS is the amount of space requested
* in the shared area.
*
parameter(nwords=50000)

call hlimap(nwords,'TEST')
*
call hbook1(1,'test1',100,-3.,3.,0.)
call hcopy(1,2,'test2')
call hcopy(1,3,'test3')
*
do 10 i=1,100000000
  call rannor(a,b)
  call hf1(1,a,1.)
  call hf1(2,b,1.)
  call hf1(3,a**2+b**2,1.)
  if(mod(i,100000).eq.0)
    X print *,' hserver in loop index ',i
10 continue
*
end

$ f77 -L... -l... -ohserver hserver.f

$ hserver
GLOBAL MEMORY CREATED,
  offset from LQ = 1037452510

hserver in loop index 100000
hserver in loop index 200000
hserver in loop index 300000
hserver in loop index 400000
hserver in loop index 500000
hserver in loop index 600000
hserver in loop index 700000

```

```

PAW > edit shared
macro shared ntimes=100
histo/plot 1 K
do nt = 1,[ntimes]
  histo/plot 1 U
  wait ' ' 1
enddo
return
PAW > global_sect TEST
PAW > exec shared ntimes=15

```

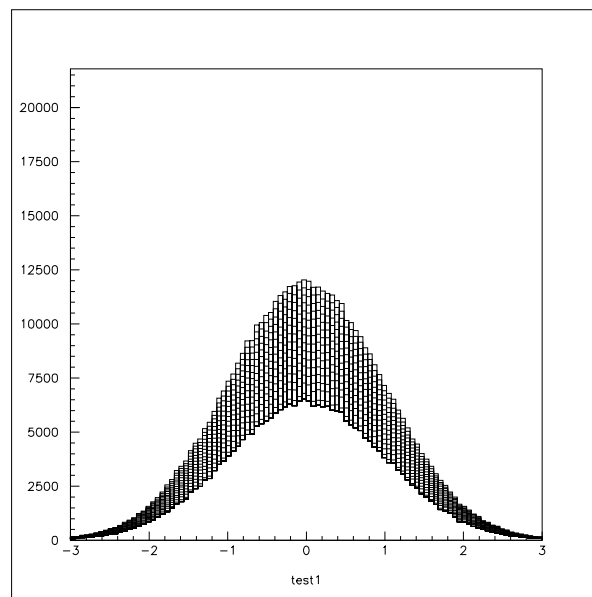

Figure 9.2: Visualise histograms in Unix shared memory

On Unix PAW can be used as an online presenter using the shared memory facility (at present on Sun and DecStation only) and the routines described in section 9.3. Figure 9.2 shows on the left hand side the program, which fills the histograms. It is compiled and linked with the f77 command, and then started. It writes the lines shown while going through the event loop. Then PAW is started, communication is established via the command global\_sect TEST, which declares that the area called 'MAP' is to be shared for data communication, and the execution of the KUMAC program shared.kumac, shown at the top right of the figure, is initiated.

The output shown on the screen then allows one to follow interactively (using the Update option 'U' of the plot command) how the event generator (the hserver program) fills histogram number one. The first fifteen iterations have been captured and are shown at the bottom right of Fig. 9.2.





## Chapter 10: HBOOK Tabular Overview

Table 10.1: HBOOK Routine calling sequences

Calling Sequence	page
CALL HARRAY (ID,NWORDS,LOC*)	56
CALL HBANDX (ID,YMI,YMA,VMX)	53
CALL HBANDY (ID,XMI,XMA,VMX)	53
CALL HBARX (ID)	54
CALL HBARY (ID)	54
CALL HBAR2 (ID)	54
CALL HBFUN1 (ID,CHTITL,NX,XMI,XMA,FUN)	55
CALL HBFUN2 (ID,CHTITL,NX,XMI,XMA,NY,YMI,YMA,FUN)	55
CALL HBIGBI (ID,NCOL)	80
CALL HBINSZ ('YES'/'NO')	52
CALL HBNAMC (ID,CHBLOK,IADDR,CHFORM)	25
CALL HBNAME (ID,CHBLOK,IADDR,CHFORM)	25
CALL HBNT (ID,CHTITL,CHOPT)	24
CALL HBOOKB (ID,CHTITL,NCX,XBINS,VMX)	51
CALL HBOOKN (ID,CHTITL,NVAR,CHRZPA,NPRIME,CHTAGS)	20
CALL HBOOKNC (ID,CHTITL,NVAR,BLOCK,TUPLE,CHTAGS)	27
CALL HBOOK1 (ID,CHTITL,NX,XMI,XMA,VMX)	14
CALL HBOOK2 (ID,CHTITL,NX,XMI,XMA,NY,YMI,YMA,VMX)	14
CALL HBPRO (ID,VMX)	52
CALL HBPROF (ID,CHTITL,NCX,XLOW,XUP,YMIN,YMAX,CHOPT)	51
CALL HBPROX (ID,VMX)	53
CALL HBPROY (ID,VMX)	53
CALL HBSET (OPTION,IVAL,IERR*)	24
CALL HBSLIX (ID,NSLI,VMX)	53
CALL HBSLIY (ID,NSLI,VMX)	53
CALL HCDIR (*CHPATH*,CHOPT)	161
CALL HCOMPA (IDVECT,N)	81
CALL HCONVOL (ID1,ID2,ID3,IERROR*)	38
CALL HCOPY (ID1,ID2,CHTITL)	17
CALL HCOPYM (ID,IPAWD,IOFSET)	173
variab = hcreateg(global_name,base_common,size)	173
CALL HDDIR (CHPATH)	162
CALL HDELET (ID)	17
CALL HDERIV (DERIV)	116
CALL HDIFF (ID1,ID2,PROB*,CHOPT)	101

Table 10.1: HBOOK Routine calling sequences (cont.)

Calling Sequence	page
CALL HDIFFB (ID1, ID2, TOL, NBINS, CHOPT, NBAD*, DIFFS*)	104
CALL HDUMP (ID)	98
CALL HERMES (LERR)	85
LOGVAR = HEXIST (ID)	92
CALL HFC1 (ID, IBIN, CLAB, W, CHOPT)	61
CALL HFC2 (ID, IBINX, CLABX, IBINY, CLABY, W, CHOPT)	61
CALL HFF1 (ID, NID, X, WEIGHT)	59
CALL HFF2 (ID, NID, X, Y, W)	59
CALL HFILL (ID, X, Y, WEIGHT)	15
CALL HFINAM (ID, CHPNAM, NPAR)	114
CALL HFITEX (ID, AA*, BB*, CHI2*, IC, SIG*)	123
CALL HFITGA (ID, C*, AV*, SD*, CHI2*, IC, SIG*)	123
CALL HFITH (ID, FUN, CHOPT, NP, PARAM*, STEP, PMIN, PMAX, SIGPAR*, CH2*)	111
CALL HFITHN (ID, CHFUN, CHOPT, NP, *PAR*, STEP, PMIN, PMAX, SIGPAR*, CHI2*)	112
CALL HFITL (ID, FUN, NP, *P*, CHI2*, IC, SIG*, COV*, ST, PMI, PMA)	122
CALL HFITN (X, Y, EY, NPTS, N1, NVAR, FUN, NP, *P*, CHI2*, IC, SIG*, COV*)	122
CALL HFITPO (ID, NP, A*, CHI2*, IC, SIG*)	123
CALL HFITS (ID, FUN, NP, *P*, CHI2*, IC, SIG*)	122
CALL HFITV (N, NDIM, NVAR, X, Y, EY, FUN, CHOPT, NP, PARAM, STEP, PMIN, PMAX, SIGPAR, CHI2)	113
CALL HFIT1 (X, Y, EY, N, FUN, NP, *P*, CHI2*, IC, SIG*)	123
CALL HFN (ID, X)	20
CALL HFNOV (ID, X)	21
CALL HFNT (ID)	27
CALL HFNTB (ID, CHBLOK)	27
CALL HFPAK1 (ID, NID, V, N)	59
CALL HFUNC (ID, FUN)	55
variab = hfree(global_size, base_common, offset)	174
CALL HF1 (ID, X, WEIGHT)	58
CALL HF1E (ID, X, WEIGHT, ERRORS)	58
CALL HF2 (ID, X, Y, WEIGHT)	59
CALL HGFIT (ID, NFPAR, NPFITS, FITCHI, FITPAR, FITSIG, FITNAM)	115
CALL HGIVE (ID, CHTITL*, NX*, XMI*, XMA*, NY*, YMI*, YMA*, NWT*, LOC*)	98
CALL HGIVEN (ID, CHTITL, *NVAR*, CHTAG*, RLOW*, RHIGH*)	31
CALL HGN (ID, *IDN*, IDNEVT, X*, IERROR*)	31
CALL HGNF (ID, IDNEVT, X*, IERROR*)	31
CALL HGNPAR (ID, CHROUT)	32
CALL HGNT (ID, IROW, IERR*)	33

Table 10.1: HBOOK Routine calling sequences (cont.)

Calling Sequence	page
CALL HGNTB (ID,CHBLOK,IROW,IERR*)	34
CALL HGNTF (ID,IROW,IERR*)	35
CALL HGNTV (ID,CHVAR,NVAR,IROW,IERR*)	34
VARIAB = HI (ID,I)	94
CALL HIDALL (IDVECT*,N*)	92
CALL HIDOPT (ID,CHOPT)	78
CALL HID1 (IDVECT*,N*)	92
CALL HID2 (IDVECT*,N*)	92
VARIAB = HIE (ID,I)	95
VARIAB = HIF (ID,I)	96
VARIAB = HIJ (ID,I,J)	94
CALL HIJXY (ID,I,J,X*,Y*)	96
CALL HINDEX	78
CALL HIPAK1 (ID,NID,IV,N)	60
CALL HISTDO	16
CALL HIX (ID,I,X*)	96
CALL HKIND (ID,KIND*,CHOPT)	93
CALL HLABEL (ID,NLAB,*CLAB*,CHOPT)	57
CALL HLDIR (CHPATH,CHOPT)	161
CALL HLIMAP (NWORDS,CHNAME)	176
CALL HLIMIT (NPPAW)	158
CALL HLNEXT (*IDH*,CHTYPE*,CHTITL*,CHOPT)	163
CALL HLOCAT (ID,LOC*)	158
variab = hmapg(global_name,base_common,offset)	174
VARIAB = HMAX (ID)	97
CALL HMAXIM (ID,FMAX)	81
CALL HMCINI (IDDATA,IDMC,IDWT,NSRC,CHOPT,IERR)	140
VARIAB = HMCLNL (FRAC)	140
CALL HMCMLL (IDD,IDM,IDW,NSRC,CHOPT,IFIX,FRAC,FLIM,START,STEP,UP,PAR*,DPAR*)	139
CALL HMDIR (CHPATH,CHOPT)	160
CALL HMERGE (NFILES,CHFIN,CHFOUT)	168
CALL HMERGIN	168
VARIAB = HMIN (ID)	97
CALL HMINIM (ID,FMIN)	81
CALL HNOENT (ID,NOENT*)	92
CALL HNORMA (ID,XNORM)	82
CALL HNTDUP (ID1,ID2,NEWBUF,CHTITL,CHOPT)	38

Table 10.1: HBOOK Routine calling sequences (cont.)

Calling Sequence	page
CALL HNTVDEF (ID1,IVAR,CHTAG,BLOCK,ITYPE)	35
CALL HOPERA (ID1,CHOPER,ID2,ID3,C1,C2)	100
CALL HOUTPU (LOUT)	85
CALL HPAGSZ (NLINES)	83
CALL HPAK (ID,CONTEN)	60
CALL HPAKAD (ID,CONTEN)	60
CALL HPAKE (ID,ERRORS)	60
CALL HPARAM (ID,IC,R2MIN,MAXPOW,COEFF*,ITERM*,NCO*)	126
CALL HPARMN (X,Y,EY,NP,NVAR,IC,R2MIN,MAXPOW,COEFF*,ITERM*,NCO*)	129
CALL HPCHAR (CHOPT,CHAR)	80
CALL HPDIR (CHPATH,CHOPT)	162
CALL HPHIST (ID,CHOICE,NUM)	83
CALL HPHS (ID)	84
CALL HPHST (ID)	84
CALL HPONCE	85
CALL HPRINT (ID)	16
CALL HPRNT (IDN)	27
CALL HPROJ1 (ID,IDN,ISEL,FUN,IFROM,ITO,IVARX)	30
CALL HPROJ2 (ID,IDN,ISEL,FUN,IFROM,ITO,IVARX,IVARY)	31
CALL HPROT (ID,CHOICE,NUM)	84
CALL HPSCAT (ID)	84
CALL HPTAB (ID)	84
CALL HQUAD (ID,CHOPT,MODE,SENSIT,SMOOTH,NSIG*,CHISQ*,NDF*,FMIN*,FMAX*,IERR*)	131
CALL HRDIR (MAXDIR,CHDIR*,NDIR*)	163
CALL HREBIN (ID,X*,Y*,EX*,EY*,N,IFIRST,ILAST)	97
CALL HRECOV (ID,CHOPT)	28
CALL HRENAME (ID1,CHOLD,CHNEW)	38
CALL HREND (CHTOP)	169
CALL HRENID (IDOLD,IDNEW)	17
CALL HRESET (ID,CHTITL)	17
CALL HRFILE (LUN,CHTOP,CHOPT)	166
CALL HRGET (ID,CHFILE,CHOPT)	165
CALL HRIN (ID,ICYCLE,IOfSET)	167
VARIAB = HRNDM1 (ID)	133
CALL HRNDM2 (ID,RX*,RY*)	133
CALL HROPEN (LUN,CHTOP,CHFILE,CHOPT,LREC,ISTAT*)	165
CALL HROUT (ID,ICYCLE*,CHOPT)	167

Table 10.1: HBOOK Routine calling sequences (cont.)

Calling Sequence	page
CALL HRPUT (ID,CHFILE,CHOPT)	164
CALL HSCALE (ID,FACTOR)	82
CALL HSCR (ID,ICYCLE,CHOPT)	168
CALL HSETPR (CHNAME,VALUE)	128
CALL HSMOOF (ID,ICASE,CHI2*)	130
VARIAB = HSPFUN (ID,X,N,K)	131
CALL HSPLI1 (ID,IC,N,K,CHI2*)	130
CALL HSPLI2 (ID,NX,NY,KX,KY)	131
CALL HSQUEZ ('YES'/'NO')	83
CALL HSTAF (CHOPT)	80
VARIAB = HSTATI (ID,ICASE,CHOICE,NUM)	99
VARIAB = HSUM (ID)	98
CALL HTITLE (CHGTIT)	78
CALL HUNPAK (ID,CONTEN*,CHOICE,NUM)	94
CALL HUNPKE (ID,CONTEN*,CHOICE,NUM)	95
CALL HUWFUN (LUN,ID,CHFUN,CHFILE,ITRUNC,CHOPT)	35
VARIAB = HX (ID,X)	94
VARIAB = HXE (ID,X)	95
CALL HXI (ID,X,I*)	96
VARIAB = HXY (ID,X,Y)	94
CALL HXYIJ (ID,X,Y,I*,J*)	96



## Bibliography

- [1] L. Lamport. *L<sup>A</sup>T<sub>E</sub>X A Document Preparation System (Second Edition)*. Addison-Wesley, 1994.
- [2] CN/ASD Group. *HIGZ/HPLOTT Users Guide*, Program Library Q120 and Y251. CERN, 1993.
- [3] CN/ASD Group. *PAW users guide*, Program Library Q121. CERN, October 1993.
- [4] various authors. *SUMX User's Manual* Program Library Y200. CERN, 1976. 1973 (Rev. 1976).
- [5] R. Brun, M. Hansroul, and P. Palazzi. *HBOOK users guide (Version 1.2)*, Program Library Y250. CERN, 1973.
- [6] R. Brun, M. Hansroul, P. Palazzi, and B. Peuchot. *HBOOK users guide (Version 2)*, Program Library Y250 and DD/75/11. CERN, 1975.
- [7] R. Brun, I. Ivanchenko, and P. Palazzi. *HBOOK users guide (Version 3)*, Program Library Y250 and DD/77/9. CERN, 1977.
- [8] R. Brun, I. Ivanchenko, D. Lienart, and P. Palazzi. *HBOOK users guide (Version 3 - Revised)*, Program Library Y250 and DD/EE/81-1. CERN, 1984.
- [9] R. Brun and D. Lienart. *HBOOK users guide (Version 4)*, Program Library Y250. CERN, 1987.
- [10] CN/ASD Group and J. Zoll/ECP. *ZEBRA Users Guide*, Program Library Q100. CERN, 1993.
- [11] W. T. Eadie, D. Drijard, F. James, M. Roos, and B. Sadoulet. *Statistical Methods in Experimental Physics*. North-Holland, 1971.
- [12] CN/ASD Group. *MINUIT – Users Guide*, Program Library D506. CERN, 1993.
- [13] J. H. Friedman. Data Analysis Techniques for High Energy Particle Physics. In CERN, editor, *Proceedings of the 1974 CERN School of Computing, Godoyssund (Norway)*, 1974. CERN Report 74-23.
- [14] B. Schorr. Spline estimation of Distributions and Density Functions. Technical Report DD/75/13, CERN, 1975.
- [15] B. Schorr. Etude du lissage d'histogramme par la méthode des B-splines et implementation dans HBOOK. Technical Report DD/EE/78-3, CERN, 1978.
- [16] J. Allison. Multiquadratic Radial Basis Functions for Representing Multidimensional High Energy Physics Data. *Comp. Phys. Comm.*, 77:377–395, 1993.
- [17] Roger Barlow and Christine Beeston. Fitting using finite Monte Carlo Samples. *Comp. Phys. Comm.*, 77:219, 1993.
- [18] Roger Barlow. Fitting using finite Monte Carlo Samples. *J. Comp. Phys.*, 72:202, 1987.
- [19] CERN. *CSPACK – Client Server Computing Package*, Program Library Q124, 1991.

## Index

- 'N', 114
- 'Q', 166
- 'S', 61
- 'SA', 57
- 'U', 61, 115
- /PAWMAP/ common, 173
- 3530h, 129
  
- access to histogram information, 92
- add histograms, 100
- analytic function, 123
- array, 60
- attribute, 158
  
- B-splines, 129
- band, 158
- bin
  - histogram rebinning, 97
- BLAC, 80
- block, 26
- BSIZE, 25
  
- CERNVM, 170
- change directory, 171
- channel contents, 92
- character type, 4
- CHFILE, 165, 166
- Chisquare test, 102
- CHOPT, 24
- circular buffer, 21
- CLABX, 61
- CLABY, 61
- client, 179
- common /PAWMAP/, 173
- common /PAWC/, 4, 5, 18, 19, 25, 56, 98, 129, 157, 158, 160, 173, 176
- confidence level, 103
- Convolution
  - Ntuple, 38
- covariance matrix, 124
- current directory, 22, 171
- CWN, *see* Ntuple, Column-Wise-Ntuple
  
- data acquisition system, 173
- data structure, 157
- data summary tape, 18
  
- DecStation, 176
- Deprecated routines, 122–123
- difference
  - between histograms, 101
- direct access file, 164
- directory, 160, 171
  - change, 171
  - current, 22, 171
- divide histograms, 100
- DST, 1, 8, *see* data summary tape
- Duplicate
  - Ntuples, 38
  
- EDM, 120, 122
- elementary function, 123
- equivalent event, 99
- ERR0, 54
- error, 60, 158
  - return codes, *see* IREQUEST
- errors on fitted parameters, 117
- exchange mode, 170
- existence of histogram, 92
- expansion of function, 123
- exponential
  - fit, 112
  
- F-test, 124
- fit, 110
  - exponential, 112
  - gaussian, 112
  - polynomial, 112
- fitting, 110–116
- fitting Monte Carlo statistics, 133–156
- floating number, 59
- Fortran, 92
- Fortran convention, 4
- FPARAM, 129
- ftp, 170
- FUN, 115, 116
  
- gaussian
  - fit, 112
- global section, 173, 175, 177
- global\_sect, 175–177
  
- H1EVL1, 93

- H2PAGE, 93  
 HARRAY, 16, **56**  
 HBANDX, 53, **53**  
 HBANDY, **53**  
 HBAR2, 54, **54**  
 HBARX, 54, **54**, 56, 58, 60, 93, 95, 100, 102, 110,  
     126, 160  
 HBARY, 54, **54**, 59, 93  
 HBASFT, 127  
 HBFUN1, **55**, 80, 133  
 HBFUN2, **55**, 133  
 HBIGBI, 80, **80**, 93  
 HBINSZ, 52, **52**  
 HBLACK, 93  
 HBNAMC, 18, 24, **25**, 26, 27, 33–35  
 HBNAME, 18, 24, **25**, 26, 27, 33–35  
 HBNT, 18, 24, **24**, 25, 27, 29, 35, 160  
 HBOOK, 1, 12, 56, 116, 157, 158, 160, 161, 164,  
     165, 170, 171  
 HBOOK1, 5, **14**, 30, 51, 53, 55, 78, 80, 93, 160  
 HBOOK2, 5, **14**, 55, 57, 80, 93  
 HBOOKB, **51**  
 HBOOKN, 18, **20**, 21, 22, 27, 31, 32, 160  
 HBOOKNC, **27**  
 HBPRO, **52**, 53  
 HBPROF, **51**  
 HBPROX, **53**  
 HBPROY, **53**  
 HBSET, 19, 23, **24**  
 HBSLIX, 53, **53**  
 HBSLIY, **53**  
 HBSTAT, 93  
 HCDIR, 24, **161**, 167, 171, 173  
 /HCFITD/ fit parameters common, 111, 113, 115  
 HCOMPA, **81**  
 HCONVOL, **38**  
 HCOPY, **17**  
 HCOPLYM, **173**  
 hcreatg, **173**  
 HDDIR, **162**  
 HDELET, **17**  
 HDERIV, 111–113, **116**, 117  
 HDIFF, i, 101, **101**, 102–106, 168  
 HDIFFB, i, **104**, 105, 106, 108, 109  
 HDUMP, **98**  
 HELEFT, 127  
 HERMES, 85, **85**  
 HERROR, 93  
 HESSE, 111, 112, 114, 118, 140  
 HEXIST, 92, **92**  
 HF1, 58, **58**, 59  
 HF1E, **58**  
 HF2, 54, 58, 59, **59**  
 HFC1, 57, 61, **61**, 62  
 HFC2, 57, 61, **61**, 62  
 HFCNH, 116  
 HFCNV, 116  
 HFF1, 59, **59**  
 HFF2, **59**  
 HFILL, 5, **15**, 51, 54, 58, 59  
 HFINAM, **114**, 115  
 HFIT1, **123**  
 HFITEX, **123**  
 HFITGA, **123**  
 HFITH, 110, **111**, 114–116, 119, 122  
 HFITHN, 110, **112**, 114, 115, 123  
 HFITL, **122**  
 HFITN, 116, **122**  
 HFITP0, **123**  
 HFITS, **122**  
 HFITV, 110, **113**, 115, 116, 119, 122, 123  
 HFN, 18, **20**, 21, 22  
 HFNOV, 21, **21**  
 HFNT, 18, 24, 27, **27**, 29, 46  
 HFNTB, 18, 23, **27**  
 HFPK1, **59**, 60  
 hfree, **174**  
 HFUNC, **55**, 56, 80, 93, 160  
 HGFIT, **115**  
 HGIVE, **98**  
 HGIVEN, **31**  
 HGN, 18, 31, **31**, 32  
 HGNF, 18, 31, 32, **32**  
 HGMPAR, 31, 32, **32**  
 HGNT, 18, 25, **33**, 35  
 HGNTB, 18, 25, **34**, 35, 37  
 HGNTF, 18, 25, **35**  
 HGNTV, 18, 25, 34, **34**, 35, 37  
 HI, 94, **94**  
 HID1, 92, **92**  
 HID2, **92**  
 HIDALL, **92**

- HIDOPToption
  - BLAC, 80
  - ERR0, 54
  - NPST, 77
  - PERR, 54
  - PFUN, 55
  - ROTA, 83, 84
  - STAR, 80
  - STAT, 54, 58, 80, 99, 100
  - TABL, 15
- HIDOPT, 78, **78**, 79
- HIE, 95, **95**
- HIF, **96**
- HIGZ, 12, 157
- HIJ, 94, **94**
- HIJXY, **96**
- HINDEX, **78**, 162
- HINTEG, 93
- HIPAK1, **60**
- HISTD0, 5, 16, **16**, 77, 78, 83, 85
- histogram, 2, 3
  - addition, 100
  - copy, 17
  - deletion, 17
  - division, 100
  - identifier, 4, 14
  - multiplication, 100
  - operations, 100
  - packing, 59, 60
  - profile, 51
  - rebinning, 97
  - rename, 17
  - reset, 17
  - subtraction, 100
  - title, 14
- HIX, **96**
- HKIND, **93**
- HLABEL, v, 57, **57**, 61, 62, 64
- HLDIR, **161**, 167
- HLIMAP, 176, **176**
- HLIMIT, 4, 5, 18, 25, 157, 158, **158**, 176
- HLNEXT, **163**
- HLOCAT, 56, **158**
- HLOGAR, 93
- hmapg, **174**
- HMAX, **97**
- HMAXIM, **81**, 93
- HMCINI, 139, 140, **140**
- HMCLNL, 136, 138–140, **140**
- HMCMLL, i, 138, 139, **139**
- HMDIR, **160**, 167
- HMERGE, 168, **168**
- HMERGIN, **168**
- HMIN, **97**
- HMINIM, **81**, 93
- HNOENT, 31, **92**
- HNORMA, **82**, 93
- HNTDUP, **38**
- HNTVDEF, **35**
- HOPERA, 100, **100**, 168
- HOUTPU, 85, **85**
- HPAGSZ, **83**
- HPAK, 60, **60**, 106
- HPAKAD, **60**
- HPAKE, 54, 56, 60, **60**, 106, 110, 126
- HPARAM, 123, **126**, 127, 129
- HPARMN, 123, 124, **129**
- HPCHAR, **80**
- HPDIR, **162**
- HPHIST, **83**, 84
- HPHS, 84, **84**
- HPHST, **84**
- HPLCAP, 12
- HPLEND, 12
- HPLINT, 12
- HPLOT, 1, 12, 54, 57, 173
- HPONCE, 85, **85**
- HPRCHA, 93
- HPRCON, 93
- HPRERR, 93
- HPRFUN, 93
- HPRHIS, 93
- HPRINT, 16, **16**, 77, 83, 84, 162
- HPRL0W, 93
- HPRNT, **27**
- HPROJ1, **30**, 31
- HPROJ2, **31**
- HPROT, **84**
- HPRSTA, 93
- HPSCAT, **84**
- HPTAB, **84**
- HQUAD, i, 129, 131, **131**

- HRDIR, **163**  
 HREBIN, **97**  
 HRECOV, **28**  
 HRENAME, **38**  
 HREND, 27, 29, 165, 166, 169, **169**, 171  
 HRENID, **17**  
 HRESET, **17**  
 HRFILE, 20, 161, 166, **166**, 167, 169, 171, 173  
 HRGET, 165, **165**  
 HRIN, 157, 161, 165, **167**, 168, 173  
 HRNDM1, 133, **133**  
 HRNDM2, **133**  
 HROPEN, 18–25, 27, 160, 165, **165**, 166, 167, 170, 171  
 HROTAT, 93  
 HROUT, 24, 27–29, 114, 157, 161, 165, 167, **167**, 173  
 HRPUT, **164**, 165  
 HRVAL, 125  
 HSCALE, **82**, 93  
 HSCR, **168**  
 HSELBF, 125, 127, 128  
 HSETPR, 125, 127, 128, **128**  
 HSMOOF, 129, **130**  
 HSPFUN, 129, **131**  
 HSPLI1, 129, 130, **130**, 131  
 HSPLI2, 129, **131**  
 HSQUEZ, **83**  
 HSTAF, **80**  
 HSTAR, 93  
 HSTATI, **99**, 109  
 HSUM, **98**  
 HTABLE, 77, 93  
 HTITLE, 5, **78**  
 HUNPAK, 83, **94**, 99  
 HUNPKE, **95**  
 HUWFUN, 25, 33, 35, **35**, 36  
 HX, **94**  
 HXE, **95**  
 HXI, **96**  
 HXY, **94**  
 HXYIJ, **96**
- I/O, 164  
 IBINX, 61, 62  
 IBINX=0, 61  
 IBINY, 61  
 IBINY=0, 61  
 identifier, 4  
 input, 164  
 integer number, 60  
 integer type, 4  
 IREQUEST communication vector, 22, 111, 112, 164, 166
- Kolmogorov test, 101, 102  
 KUIP, 157
- limits on fitted parameters, 117  
 line printer, 16  
 log-likelihood, 110  
 LREC, 170  
 LRECL, 18, 19
- mean value, 92, 99  
 memory, 21  
 MIGRAD, 117, 118  
 minimisation, 110  
 MINOS, 111, 112, 114, 140  
 MINUIT, 112, 113, 116–122, 139  
 monomial, 123  
 Monte Carlo statistics, 133–156  
 multiply histograms, 100  
 multiquadric, 129  
 MZEBRA, 4
- NFPAR, 115  
 nfs, 170  
 NPST, 77  
 NTUPLE, 93  
 Ntuple, 2, 3, 18–50, 164, 165  
   Column-Wise-Ntuple, 18, 19, 22–28, 33, 35, 37, 46, 168  
   convolution, 38  
   disk resident, 20, 21  
   duplicate, 38  
   identifier, 4  
   memory resident, 20, 21  
   operation, 38  
   rename column, 38  
   reset, 17  
   Row-Wise-Ntuple, 18, 20, 21, 23, 27, 31, 32, 35, 38, 40, 168

- null hypothesis, 103
  - NWBUFF, 18, 21
  - NWPAWC, 158
- one-dimensional histogram, 14
- online, 164
- OS9, 179
- output, 164
- overflow, 99
- packing, 4, 14, 59, 60
- parameter
  - errors (fit), 117
  - parameter type, 4
  - parametrization, 123–129
  - pathname, 171
- PAW, 1, 18, 21–23, 27, 31, 35, 37, 45, 54, 57, 80, 111, 116, 117, 119, 131, 157, 168, 171, 173, 176, 178
  - server, 179
- PAW++, 170
- /PAWC/ common, 4, 5, 18, 19, 25, 56, 98, 129, 157, 158, 160, 173, 176
- PAWMAP common, 173
- PERR, 54
- PFUN, 55
- Poisson distribution, 110
- polynomial
  - fit, 112
- presenter, 175, 177, 179
- print, 16
- profile histogram, 51
- projection, 60, 158
- /QUEST/, *see* IQUEST
- random number generation, 133
- real type, 4
- rebinning, 97
- regressor, 124
- remote
  - file, 178
  - login, 178, 179
  - shell, 178, 179
- Rename
  - column in Ntuple, 38
- Reset
  - histogram, 17
  - Ntuple, 17
- resize command (VMS), 170
- RLOGIN, 178, 179
- ROTA, 83, 84
- RSHELL, 178, 179
- RWN, *see* Ntuple, Row-Wise-Ntuple
- RZ file, 18
- RZ package of ZEBRA, 164
- RZPURG, 167
- saturation, 102
- scatter-plot, 2
- server, 179
- shared memory, 176, 177
- slice, 60
- Smirnov-Cramer-Von-Mises test, 103
- smoothing, 129–132
- standard deviation, 92, 99
- STAR, 80
- STAT, 54, 58, 80, 99, 100
- subtract histograms, 100
- Sun, 176
- TABL, 15
- table, 2
- Taylor expansion, 123
- TCP/IP, 179
- test
  - Kolmogorov, 101
- TKOLM0, 103
- two-dimensional histogram, 14
- type
  - character type, 4
  - integer, 4
  - parameter, 4
  - real, 4
- underflow, 99
- Unix, 160, 165, 166, 170, 176, 177
- VAX, *see* VMS
- VAX/VMS, 175
- VM/CMS, 165, 166, 171
- VMS, 170, 171, 175
- VMX, 4, 14
- VMX, 160

W, 61

weight, 15

XZRZ0P, 162

ZEBRA, 157–160, 164, 167, 171

    RZ package, 164, 171